

SXE Ball Check Valves

Product Data Sheet



< STANDARDS >



ASTM D1784
ASTM F441
ASTM D2464
ASTM D2466
ASTM D2467
ASTM F439
ASTM F437
ASTM F1498



ANSI B1.20.1
ANSI B16.5



Certified to
NSF/ANSI 61-G

The IPEX EasyFit SXE Series Ball Check Valves represent the latest innovation in thermoplastic valve manufacturing technology. The SXE introduces an advanced method of installation, providing trouble free service for industrial, OEM and water service applications. This popular style of check valve features a true union design allowing for easy removal and maintenance of the valve without disturbing the rest of the pipe assembly. Positive shutoff of the valve in both vertical and horizontal installations is achieved with just 3 psi of back pressure. The innovative SXE EasyFit design features a custom labelling system, and the optional EasyFit multifunctional handle allows for union nut rotational control and safe blocked carrier tightening.

SXE Ball Check Valves are part of our complete system of IPEX pipe, valves and fittings, engineered and manufactured to our strict quality, performance and dimensional standards.

VALVE AVAILABILITY

Body Material	PVC, CPVC
Size Range	1/2" through 4"
Pressure	232 psi
Seals	EPDM or Fluoropolymer (FPM)
End Connections	Socket (IPS), Threaded (FNPT)

Sample Specification

1.0 Check Valves – SXE

1.1 Material

- The valve body, ball, end connectors, and unions shall be made of PVC compound which shall meet or exceed the requirements of cell classification 12454 according to ASTM D1784.
- or The valve body, ball, end connectors, and unions shall be made of Corzan CPVC compound which shall meet or exceed the requirements of 23447 according to ASTM D1784.

1.2 Seals

- The o-ring seals shall be made of EPDM.
- or The o-ring seals shall be made of FPM.

2.0 Connections

2.1 Socket style

- The IPS socket PVC end connectors shall conform to the dimensional standards ASTM D2466 and ASTM D2467.
- or The IPS socket CPVC end connectors shall conform to the dimensional standard ASTM F439.

2.2 Threaded style

- The female NPT threaded PVC end connectors shall conform to the dimensional standards ASTM D2464, ASTM F1498, and ANSI B1.20.1.
- or The female NPT threaded CPVC end connectors shall conform to the dimensional standards ASTM F437, ASTM F1498, and ANSI B1.20.1.

3.0 Design Features

- The valve shall have true union ends.
- The valve cavity shall feature an optimized profile design to reduce pressure drop and improve the Cv value
- The valve cavity shall feature full body guide ribs to reduce chatter and improve seal quality.
- The ball shall be fully machined to achieve high surface finish and accurate dimensional tolerance.
- The valve body and union nuts shall have deep square style threads for increased strength.

- The Main-seal carrier shall be a safe blocked design and allow for safe disconnection of the union nuts for maintenance. The main-seal carrier shall be compatible with the EasyFit multifunctional handle and EasyFit Torque Wrench (1/2" – 2" valves) for precise component tightening.
- The union nuts shall be compatible with the EasyFit multifunctional handle and EasyFit Torque Wrench (1/2" – 2" valves) for precise tightening.
- The valve shall have a transparent plug housing for use with EasyFit Labelling System for valve identification.

3.1 Pressure Rating

- All valves shall be rated at 232 psi at 73°F.
- All valves shall be suitable for use with liquids having a specific gravity less than 0.05 lb/in³.

3.2 Markings

- All valves shall be marked to indicate size, material designation, and manufacturers name or trade mark.

3.3 Color Coding

- All PVC valves shall be color-coded dark gray.
- or All CPVC valves shall be color-coded light gray.

4.0 NSF 61 Listing

- 1/2" to 2" valves shall be listed with NSF to Standard 61 for potable water.

5.0 All valves shall be Xirtec® PVC or Xirtec® CPVC by IPEX or approved equal.

SXE Ball Check Valves

Product Data Sheet

Valve Selection

Size (inches)	Body Material	O-ring Material	IPEX Part Number		Pressur Rating
			IPS Socket	FNPT Threaded	
1/2	PVC	EPDM	052013		232 psi
		FPM	052022		
	CPVC	EPDM	052121		
		FPM	052127		
3/4	PVC	EPDM	052014		
		FPM	052023		
	CPVC	EPDM	052122		
		FPM	052128		
1	PVC	EPDM	052015		
		FPM	052027		
	CPVC	EPDM	052123		
		FPM	052133		
1-1/4	PVC	EPDM	052016		
		FPM	052028		
	CPVC	EPDM	052124		
		FPM	052134		
1-1/2	PVC	EPDM	052017		
		FPM	052030		
	CPVC	EPDM	052125		
		FPM	052135		
2	PVC	EPDM	052018		
		FPM	052120		
	CPVC	EPDM	052126		
		FPM	052136		
2-1/2	PVC	EPDM	052478	-	
		FPM	052481	-	
	CPVC	EPDM	052484	-	
		FPM	052487	-	
3	PVC	EPDM	052479	-	
		FPM	052482	-	
	CPVC	EPDM	052485	-	
		FPM	052488	-	
4	PVC	EPDM	052480	-	
		FPM	052483	-	
	CPVC	EPDM	052486	-	
		FPM	052489	-	

Body Material:

- PVC
- CPVC

Size (inches):

- 1/2
- 3/4
- 1
- 1-1/4
- 1-1/2
- 2
- 2-1/2
- 3
- 4

Seals:

- EPDM
- Fluoropolymer® (FPM)

End Connections:

- Socket (IPS)
- Threaded (FNPT)

IPEX Part Number:

SXE Ball Check Valves

Product Data Sheet

Dimensions

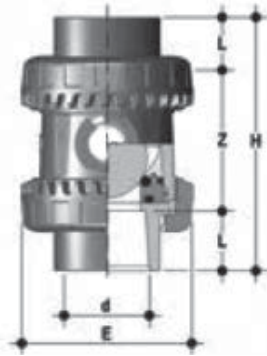

SXE IPS Socket (inches)

Size	d	L	Z	H	E
1/2	0.84	0.89	2.01	3.78	2.13
3/4	1.05	1.00	2.13	4.13	2.48
1	1.315	1.13	2.34	4.61	2.83
1-1/4	1.66	1.26	2.83	5.35	3.35
1-1/2	1.9	1.38	3.03	5.79	3.94
2	2.38	1.50	3.84	6.85	4.65

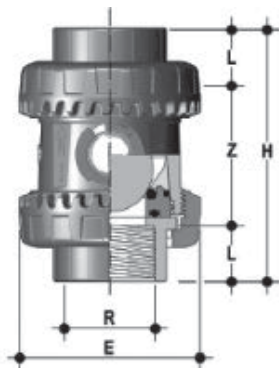

SXE NPT Female (inches)

Size	R	L	Z	H	E
1/2	1/2-NPT	0.70	2.14	3.54	2.13
3/4	3/4-NPT	0.71	2.24	3.66	2.48
1	1-NPT	0.89	2.55	4.33	2.83
1-1/4	1-1/4-NPT	0.99	3.02	5.00	3.35
1-1/2	1-1/2-NPT	0.97	3.21	5.16	3.94
2	2-NPT	1.17	4.01	6.34	4.65

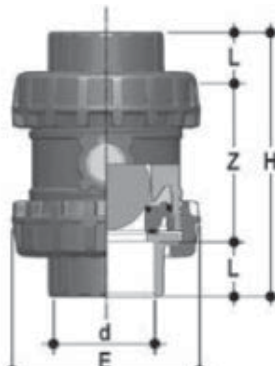

SXE IPS Socket (inches)

Size	d	L	Z	H	E
2-1/2	2.875	1.75	4.80	8.31	6.18
3	3.5	1.89	5.98	9.76	6.85
4	4.5	2.26	6.61	11.14	8.35

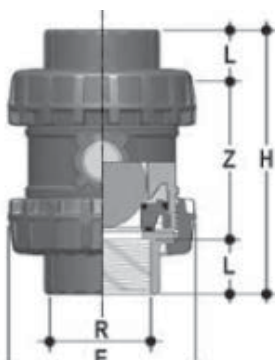

SXE NPT Female (inches)

Size	R	L	Z	H	E
2-1/2	2-1/2-NPT	1.31	5.69	8.31	6.18
3	3-NPT	1.40	6.97	9.76	6.85
4	4-NPT	1.48	8.18	11.14	8.35

SXE Ball Check Valves

Product Data Sheet

Weights

Size	PVC		CPVC	
	IPS Socket	FNPT Threaded	IPS Socket	FNPT Threaded
1/2	0.33	0.33	0.33	0.33
3/4	0.42	0.42	0.42	0.42
1	0.66	0.66	0.66	0.66
1-1/4	1.01	1.01	1.01	1.01
1-1/2	1.49	1.49	1.49	1.49
2	2.38	2.38	2.38	2.38
2-1/2	5.74	-	5.74	-
3	7.28	-	7.28	-
4	12.72	-	12.72	-

Pressure – Temperature Ratings

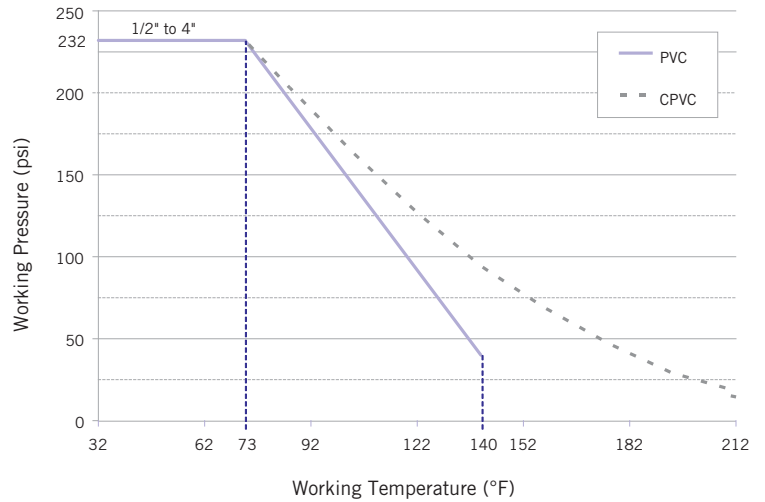

Flow Coefficients

Size	C _v
1/2	10.6
3/4	17.9
1	30.0
1-1/4	44.6
1-1/2	64.4
2	93.2
2-1/2	179.4
3	238.9
4	353.3

Pressure Loss Chart

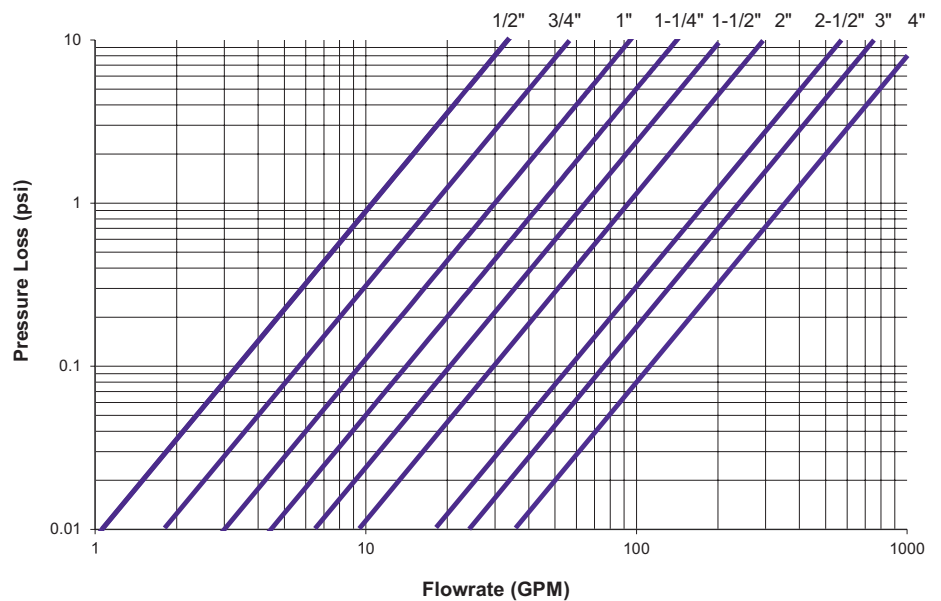

SXE Ball Check Valves

Product Data Sheet

Customize SXE EasyFit

It is often necessary to customize a valve by labelling or tagging it in order to mark, protect and identify it.



SXE EasyFit valves are therefore equipped with a plastic water-resistant module designed to meet this specific need. The module is composed of a transparent PVC service plug and a white circle tag holder, with IPEX branded on one side. The tag holder is embedded in the plug and can be easily removed to be used for self labelling on its blank side. Self labelling can be done in several ways, but we recommend designing and printing custom labels through the EasyFit Labelling System (LSE).



Please contact IPEX customer service for options and pricing on customization of SXE valves with LSE sets.

SXE Ball Check Valves

Product Data Sheet

Components

1/2" to 2"

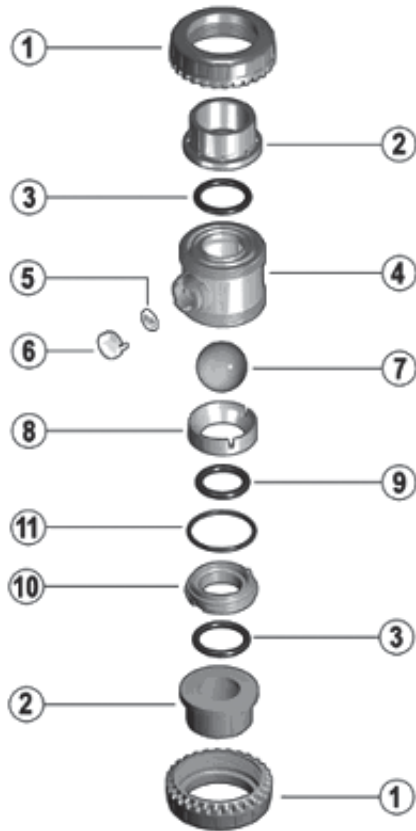

2-1/2" to 4"

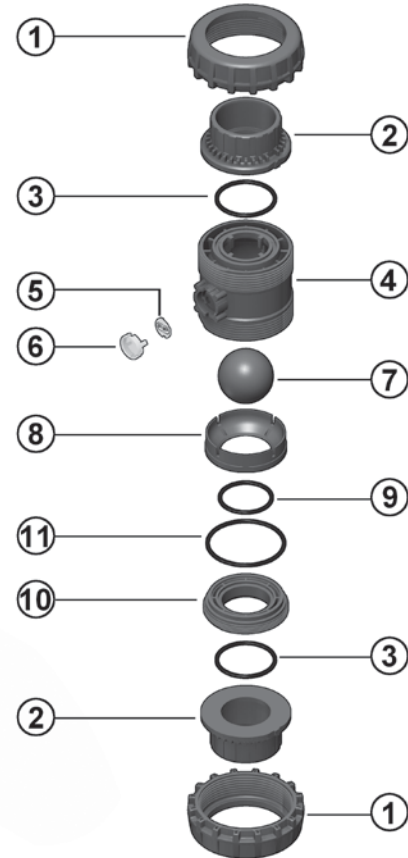

#	Component	Material	Qty
1	Union Nut	PVC	2
2	End Connector	PVC	2
3	Socket Seal (O-ring)	EPDM, FPM	2
4	Body	PVC, CPVC	1
5	Tag Holder	PVC	1
6	Transparent Service Plug	PVC	1
7	Ball	PVC	1
8	Packing-presser Ring	PVC	1
9	Ball Seal (O-ring)	EPDM, FPM	1
10	Support for Ball Seat	PVC	1
11	Radial Seal (O-ring)	EPDM, FPM	1

SXE Ball Check Valves

Product Data Sheet

Installation Procedures

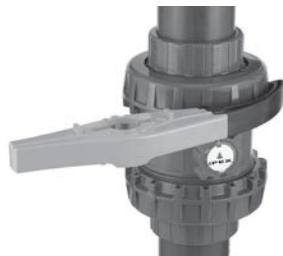

1. For socket and threaded style connections, remove the union nuts (part #1 on previous page) and slide them onto the pipe. **It is important to first check the pipe flow direction and corresponding valve orientation as installing the valve backward will prevent it from functioning as intended.**
2. Please refer to the appropriate connection style sub-section:
 - a. For socket style, solvent cement the end connectors (2) onto the pipe ends. For correct joining procedure, please refer to the section entitled, "Joining Methods – Solvent Cementing" in the IPEX Industrial Technical Manual Series, "Volume I: Vinyl Process Piping Systems". **Be sure to allow sufficient cure time before continuing with the valve installation.**
 - b. For threaded style, thread the end connectors (2) onto the pipe ends. For correct joining procedure, please refer to the section entitled, "Joining Methods – Threading" in the IPEX Industrial Technical Manual Series, "Volume I: Vinyl Process Piping Systems".
3. Ensure that the valve is in the correct orientation, and that the main seal safe blocked carrier and o-rings are properly fitted in the valve. A flow direction indicator is located on the side of the valve body. Carefully place the valve in the system between the two end connections.
4. Tighten both union nuts by hand. Hand tightening is typically sufficient to maintain a seal for the maximum working pressure. If additional tightening is required, use the EasyFit multifunctional handle tool to tighten the union nuts an additional 1/4 turn. The Easyfit torque wrench (available as an accessory for 1/2" – 2" valves) may also be used to complete the nut tightening in accordance to the torques indicated on instructions included; following this procedure will ensure the best installation.

Over-tightening may damage the threads on the valve body and/or the union nut, and may even cause the union nut to crack. It is recommended to use the EasyFit handle to prevent damage.

SXE Ball Check Valves

Product Data Sheet

Disassembly

1. If removing the valve from an operating system, isolate the valve from the rest of the system. Be sure to depressurize and drain the isolated branch and valve before continuing.
2. Loosen both union nuts (1) and drop the valve out of the line. If retaining the socket o-rings (3), take care that they are not lost when removing the valve from the line.
 - a. For 1/2" to 2" valves, remove the transparent service plug from the EasyFit multifunctional handle tool. Turn the handle over and seat on the top of the valve, ensuring the integrated gear teeth on the handle mesh with the union nut teeth. Turn clockwise to loosen.
 - b. For 2-1/2" to 4" valves, remove the EasyFit multifunctional tool from the bottom of the handle, turn it over and re-install it. Engage the tool with the outer ring profile of the union nut and loosen.
3. To disassemble, locate the main seal carrier adjustment tool on the multifunctional handle. This is found on the bottom of 1/2" to 2" handles and on the top of 2-1/2" to 4" handles.
4. Line up the moldings on the handle with the slots in the main seal carrier. Loosen and remove the main seal carrier (10) by turning it in a counter-clockwise direction.
5. Remove the Radial Seal (11), Ball Seal (9), Packing-presser Ring (8), and the Ball (7).
6. The valve components can now be checked for problems and/or replaced.

Assembly

Note: Before assembling the valve components, it is advisable to lubricate the o-rings with a water soluble lubricant. **Be sure to consult the "IPEX Chemical Resistance Guide" and/or other trusted resources to determine specific lubricant-rubber compatibilities.**

1. Insert the Remove the Ball (7), Packing-presser Ring (8), Ball Seal (9), and the Radial Seal (11) in the valve body.
2. Slightly hand tighten the main seal carrier (10) into the valve body. Line up the moldings on the handle with the slots in the main seal carrier then tighten by turning in a clockwise direction. The Easyfit torque wrench key can also be used to tighten the main seal carrier in accordance with the tightening torque values indicated on the included instructions.
3. Properly fit the socket o-rings (3) in their respective grooves.
4. Place the end connectors (2) into the union nuts (1), then thread onto the valve body taking care that the socket o-rings remain properly fitted in their grooves.
 - a. For 1/2" to 2" valves, remove the transparent service plug from the EasyFit multifunctional handle tool. Turn the handle over and seat on the top of the valve, ensuring the integrated gear teeth on the handle mesh with the union nut teeth. Turn counter-clockwise to tighten. The Easyfit torque wrench can also be used to tighten the union nuts in accordance with the tightening torque values indicated on the included instructions.
 - b. For 2-1/2" to 4" valves, remove the EasyFit multifunctional tool from the bottom of the handle, turn it over and re-install it. Engage the tool with the outer ring profile of the union nut and tighten.



Testing and Operating

The purpose of system testing is to assess the quality of all joints and fittings to ensure that they will withstand the design working pressure, plus a safety margin, without loss of pressure or fluid. Typically, the system will be tested and assessed in sub-sections as this allows for improved isolation and remediation of potential problems. With this in mind, the testing of a specific installed valve is achieved while carrying out a test of the overall system.

An onsite pressure test procedure is outlined in the IPEX Industrial Technical Manual Series, "Volume I: Vinyl Process Piping Systems" under the section entitled, "Testing". The use of this procedure should be sufficient to assess the quality of a valve installation. **In any test or operating condition, it is important to never exceed the pressure rating of the lowest rated appurtenance in the system.**

Important Points:

- Never test thermoplastic piping systems with compressed air or other gases including air-over-water boosters.
- When testing, do not exceed the rated maximum operating pressure of the valve.
- Avoid the rapid closure of valves to eliminate the possibility of water hammer which may cause damage to the pipeline or the valve.

Please contact IPEX customer service and technical support with regard to any concern not addressed in this data sheet or the technical manual.

About the IPEX Group of Companies

As leading suppliers of thermoplastic piping systems, the IPEX Group of Companies provides our customers with some of the world's largest and most comprehensive product lines. All IPEX products are backed by more than 50 years of experience. With state-of-the-art manufacturing facilities and distribution centers across North America, we have established a reputation for product innovation, quality, end-user focus and performance.

Markets served by IPEX group products are:

- Electrical systems
- Telecommunications and utility piping systems
- Industrial process piping systems
- Municipal pressure and gravity piping systems
- Plumbing and mechanical piping systems
- Electrofusion systems for gas and water
- Industrial, plumbing and electrical cements
- Irrigation systems
- PVC, CPVC, PP, PVDF, PE, ABS, and PEX pipe and fittings

Xirtec® is a registered trademark used under license.

Xirtec® CPVC piping systems are made with Corzan® CPVC compounds.

Corzan® is a registered trademark of the Lubrizol Corporation.

This literature is published in good faith and is believed to be reliable. However, it does not represent and/or warrant in any manner the information and suggestions contained in this brochure. Data presented is the result of laboratory tests and field experience.

A policy of ongoing product improvement is maintained. This may result in modifications of features and/or specifications without notice.