

# NONMETALLIC LIGHT FIXTURES



*Sceptalight™*



ELECTRICAL SYSTEMS

- LED Light Fixture
- Incandescent Light Fixture
- Compact Fluorescent Light Fixture

  
**IPEX**  
by aliaxis

[www.ipexna.com](http://www.ipexna.com)

# SCEPTALIGHT™: THE LIGHT THAT LASTS.

Whether you're looking for economical outdoor lighting solutions, corrosion-resistant fixtures for punishing industrial environments or energy-saving LED, Sceptalight fixtures from IPEX prove themselves to be all-round performers in a variety of indoor and outdoor applications. Sceptalight fixtures are made from a glass-reinforced thermoplastic polyester resin, which enables them to stand up better to corrosive elements than metal. This thermoplastic design marries an unrivalled balance of strength, stiffness and toughness with all the benefits users appreciate of Scepter Rigid PVC Conduit and Fittings – long life, easy servicing and high impact-resistance.

Sceptalight's thermoplastic construction offers outstanding corrosion and chemical resistance. Silicone gaskets in Sceptalight fixtures – mounted at the base of the globe and within the ceiling box – provide a water- and vapour-tight seal which protects the electrical connections inside.

Wherever you need a lighting fixture that can withstand exposure to chemicals, fluids or harsh physical conditions, you'll find a home for Sceptalight.

## TYPICAL APPLICATIONS



! Agriculture



! Industrial/Commercial



☢ Mine Tunnel



☢ Greenhouse



☢ Waste Water



☢ Marine



## WET LOCATIONS

C22.2 No. 250

CSA Listed to UL 1598

Minimum 60°C supply conductors

CSA certified for wet locations, Sceptalight fixtures are built to withstand any environment where liquids drip, splash or flow against electrical equipment. And our polycarbonate globes are an excellent alternative to glass in punishing environments where high impact resistance is important. Sceptalight fixtures can operate in extreme temperatures and are resistant to damaging ultraviolet rays. For years, our fixtures have been proven performers on docks, wharves, decks, walkways, shipyards and a variety of other applications where exposed to the elements.

LIGHT OPTIONS	
LED	✓
Incandescent	✓
Compact Fluorescent	✓



## HAZARDOUS LOCATIONS

CSA Listed to UL 844

CLASS I, DIV 2 Groups A, B, C & D

CLASS II, DIV 2 Groups F & G

Minimum 90°C supply conductors

Sceptalight offers fixtures that are CSA certified for hazardous locations, making them the ideal choice for specific harsh industrial environments involving flammable or explosive gases, vapours or dust. Sceptalight fixtures are equipped with brass screws and inserts to ensure performance in punishing industrial conditions.

LIGHT OPTIONS	
LED	✓

## SUGGESTED SPECIFICATION

Light fixtures shall be nonmetallic and constructed of 30% glass filled polyester material exhibiting a maximum linear expansion of 1.4x10<sup>-5</sup> in./in./°F. Fixtures shall be assembled with high temperature silicone gaskets, brass inserts and screws.

Incandescent light fixtures shall be rated for use with a Maximum 150 Watt incandescent lamp. Compact fluorescent light fixtures shall be of the wattage specified and be supplied complete with lamp and ballast (high power factor, low harmonic electronic for 18 & 26 Watt fixtures).

LED light fixtures shall be third-party certified to CSA 22.2 250.0 and UL 1598C. LED light fixtures will also be NEMA 4X and IP66 rated for wash-down and corrosive environments. LED light fixtures for hazardous use locations shall be third-party certified to UL 844 for Class I Div 2 and Class II Div 2 hazardous location use.

LED Retrofit Light Engines shall be certified to CSA 22.2 no 250.1 and UL 1598C.

Approved products: Sceptalight LVPE and LVPL series light fixtures manufactured by IPEX Electrical Inc.





# SCEPTALIGHT™ LED

Sceptalight LEDs provide exceptional light quality compared to conventional light sources. Due to their wider spectral distribution, objects lit by Sceptalight LEDs are much more visible and vivid in colour.

Introducing three new Sceptalight LED products: the LED Retrofit Light Engine, the Heavy-Duty LED Light Fixture and the Utility LED Light Fixture. Sceptalight LEDs offer significant energy savings, up to 85% compared to incandescent, and up to 34% compared to fluorescents. Moreover, Sceptalight LEDs can last beyond 50,000 hours without a single need for maintenance.

Constructed of very strong and durable materials, the polycarbonate globe is impact resistant and is resistant to UV light degradation. The specially designed aluminum heat sink dissipates the heat generated by the LEDs to the exterior environment ensuring long-life and optimal performance in both hot and cold environments. Sceptalight LEDs have been tested and certified for use in indoor, outdoor, wet location, wash down and corrosive and hazardous\* environments. They are certified to the latest LED light fixture standards and NEMA 4X approved.

\*LVPF-LED-HAZ only



## RETROFIT OPTION

Sceptalight LEDs can easily retrofit onto existing installations for increased energy savings.

## CORROSION RESISTANT

Heat sink is coated with a durable e-coat layer that prevents corrosion.

## NEMA 4X AND IP66 RATED

Approved for wet locations, wash down and corrosive environments.

## HEAT DISSIPATION

Specially designed heat sink ensures long life and optimum performance for over 50,000 hours.

## ENERGY EFFICIENT

1,575 lumens of light output is produced with only 15 Watts of electricity.

## DIMMABLE

Lights are dimmable down to 5% for maximum control of the lighting environment.

## POLYCARBONATE GLOBE

Impact and weather resistant for tough environments.

## TECHNICAL SPECIFICATIONS

LUMEN OUTPUT .....	1575 LM	POWER FACTOR .....	0.98
INPUT VOLTAGE .....	120 VAC	TOTAL HARMONIC DISTORTION .....	10.5%
FREQUENCY .....	60 HZ	OPERATING TEMPERATURE .....	-40°C TO 40°C
NOMINAL POWER .....	15 W	DIMMABILITY RANGE .....	DOWN TO 5%
COLOUR TEMPERATURE .....	5000 K	RATED LIFE .....	> 50,000 HOURS
CRI .....	> 80	WARRANTY* .....	5 YEARS

## STANDARDS

PRODUCT	APPROVED USE	STANDARDS
LLED-15 (light engine only)	WET LOCATION	CSA C22.2 250, UL 1598C
LVPE-LED	WET LOCATION	CSA C22.2 250, UL 1598C
LVPF-LED-HAZ	HAZARDOUS LOCATION	CSA C22.2 250, UL 1598C, UL 844
	Class I, Div 2 Groups A, B, C & D and Class II, Div 2 Groups F & G	

## PHOTOMETRIC DATA

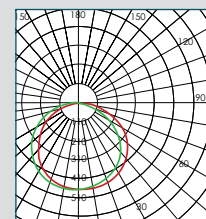

15W 120V  
Frosted LED

\*LIMITED WARRANTY & LIMITATION OF LIABILITY: Consult IPEX Sceptalight™ LED Retrofit Light Engine Specific Terms and Conditions of Sale and Limited Warranty and Limitation of Liability for further details, available at [www.ipexna.com](http://www.ipexna.com)



# SCEPTALIGHT™

## COMPACT FLUORESCENT

Sceptalight Compact Fluorescent fixtures provide lower energy and maintenance costs without sacrificing light levels. The UV resistant material makes them suitable for both indoor and outdoor use.

Sceptalight Compact Fluorescent fixtures combine the outstanding corrosion and chemical resistance of their thermoplastic design with the energy-saving advantages of compact fluorescents. Working four to five times more efficiently per watt than incandescents, Sceptalight compact fluorescents provide 10-20 times the lamp life. Without sacrificing light levels, they use 75% less energy than incandescents for a lower total energy and maintenance cost. They are available in twin tube and quad tube configurations and include ballast.

### Quad Tubes

- Available in 18 & 26 Watt
- Electronic Ballast provides "Instant Start" at temps as low as -25°C
- Offers 10,000 hours of lamp life



## STABLE CONSTRUCTION

Reinforced support feet offer secure mounting.

## ADAPTABLE

Threaded conduit hubs permit connection to nonmetallic and metallic raceways.

## WATERTIGHT SEAL

Temperature and weather-resistant gaskets protect fixture from moisture penetration.

## LONG LIFE

Sceptalight nonmetallic fixtures provide long life and easy servicing—unlike metal fixtures and guards that can corrode and seize together.

## INDOOR/OUTDOOR USE

UV-resistant material makes Sceptalight fixtures suitable for both indoor and outdoor use.

## CORROSION RESISTANT

Thermoplastic construction resists attack from acids, alcohols, alkalis, organic solvents, detergents/cleaners, greases and oils as well as many other types of chemicals. Withstands exposure to direct sunlight, heat, and extreme weather.

## DURABLE, IMPACT RESISTANCE

High-impact nonmetallic guard resists physical impact, chemical attack and heat-induced deformation.

## PHOTOMETRIC DATA

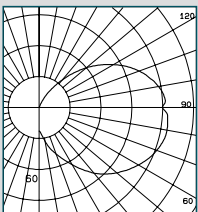

26W Quad  
Compact  
Fluorescent

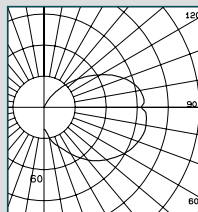

18W Quad  
Compact  
Fluorescent



# SCEPTALIGHT™

## INCANDESCENT

Sceptalight Incandescent fixtures are your cost effective solution for a variety of indoor and outdoor applications while still providing superior corrosion and chemical resistance.

Sceptalight incandescent fixtures make the most practical choice to meet the daily needs of commercial, industrial, marine and agricultural applications. Our incandescents will take up to a 150 watt incandescent bulb and are ideal for short burn times as well as flashing and dimming applications.

For light to medium duty applications that do not require the same level of ruggedness, Sceptalight has a low-cost ceiling-mounted Utility Light Fixture available in standard, clear polycarbonate and coloured heat-resistant globes.





## INSTALLATION FLEXIBILITY

Fixtures can be mounted in ceilings, or walls to accommodate installation requirements.

## INDOOR/OUTDOOR USE

Temperature and weather-resistant gaskets protect fixture from moisture penetration.

## COST EFFECTIVE SOLUTION

Inexpensive to install, the fixture takes up to a 150 watt incandescent bulb.

## ADAPTABLE LIGHTING ENVIRONMENTS

Ideal for short burn times, flashing & dimming applications.

## COLOURED GLOBES

Available in a range of coloured heat-resistant globes to transform the light into an indicator or warning light.

## CORROSION RESISTANT

Thermoplastic construction withstands exposure to direct sunlight, heat & extreme weather.

## PHOTOMETRIC DATA

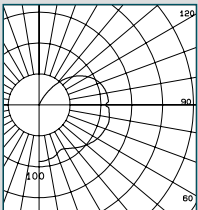

100W 120V  
Coated A19  
Incandescent

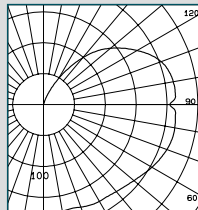

150W 120V  
Coated A21  
Incandescent

# PRODUCT CATALOGUE

## WET LOCATIONS



### Ceiling Mount with Frosted Polycarbonate Globe

Description	Part Number	Product Code	Hub Sizes
15W LED Retrofit Light Engine	LLED-15	277120	-
15W LED LVPF Heavy Duty Light Fixture	LVPF-LED-HAZ	277121	4" x 3/4"
15W LED LVPE Utility Light Fixture	LVPE-LED	277122	2" x 1/2" - 2" x 3/4"

### Ceiling Mount with Standard Clear Glass Globe

Description	Part Number	Product Code	Hub Sizes
26W Compact Fluorescent	LVPL26C	077170	4" x 3/4"
18W Compact Fluorescent	LVPL18C	077210	4" x 3/4"

### Ceiling Mount with Clear Polycarbonate Globe (no guard)

Description	Part Number	Product Code	Hub Sizes
26W Compact Fluorescent	LVPL26PCC	077176	4" x 3/4"
18W Compact Fluorescent	LVPL18PCC	077211	4" x 3/4"

### Ceiling Utility Light Fixture 150 Watt Incandescent

Description	Part Number	Product Code	Hub Sizes
w/ Standard glass globe	LVPE150-10/15	077493	2" x 1/2" - 2" x 3/4"
w/ Polycarbonate globe	LVPE150-PCC	077181	2" x 1/2" - 2" x 3/4"
w/ Standard glass globe & guard Maximum 60W incandescent lamp with polycarbonate globe	LVPE150-10/15G	077402	2" x 1/2" - 2" x 3/4"
w/ Heat-resistant glass globe RED	LVPE150HRR	077599	2" x 1/2" - 2" x 3/4"
w/ Heat-resistant glass globe BLUE	LVPE150HRB	077579	2" x 1/2" - 2" x 3/4"
Clamp-on guard for LVPE	LVPU150	077558	-

## HAZARDOUS LOCATIONS



### Ceiling Mount with Frosted Polycarbonate Globe

Description	Part Number	Product Code	Hub Sizes
15W LED LVPF Heavy Duty Light Fixture	LVPF-LED-HAZ	277121	4" x 3/4"

### Wall Mount Bracket (for WET and Hazardous Locations)

Description	Part Number	Product Code	Hub Sizes
Wall Mount bracket	LWB150	077233	-

For wall mount fixtures select and order the appropriate style (wattage and globe) ceiling mount fixture from above and add LWB150. Sceptalight compact fluorescent light fixtures are supplied complete with lamp and ballast.

All hazardous location fixtures are rated CLASS I, DIV 2 Groups A, B, C & D and CLASS II DIV 2 Groups F & G.

# MOUNTING OPTIONS

Sceptralight LED can be retrofit with Ceiling Mounts only.

## CEILING MOUNT

Box with threaded hubs and integral mounting feet

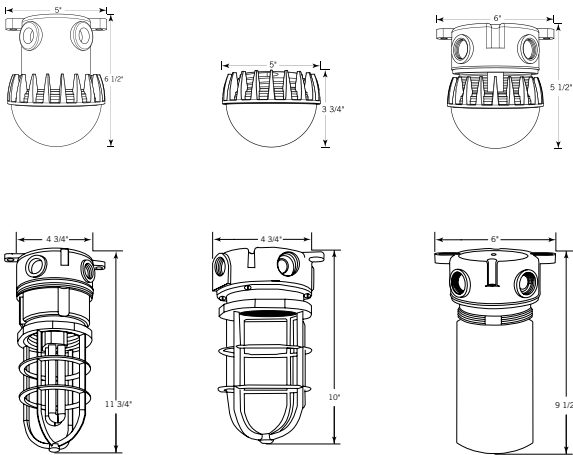

## CEILING MOUNT UTILITY FIXTURES

Box with threaded hubs and integral mounting feet

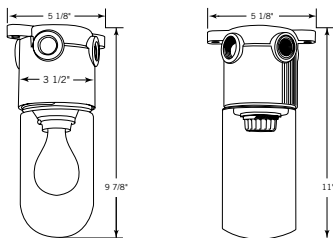

# GLOBE OPTIONS

(For incandescent and fluorescent options only)

## STANDARD CLEAR GLASS GLOBES

Ideal for general purpose area lighting for either indoor or outdoor use.

## CLEAR POLYCARBONATE GLOBES

Impact resistant globes for added protection in case of accidental contact

## COLOURED HEAT-RESISTANT GLASS GLOBES

Available in red or blue – to transform the light to an indicator or warning light.



Clear Polycarbonate



Standard or Heat-Treated Clear Glass



Heat-Treated Blue Glass



Heat-Treated Red Glass

## SALES AND CUSTOMER SERVICE

Customers call IPEX Electrical Inc.

**Toll free: (866) 473-9462**

**[www.ipexna.com](http://www.ipexna.com)**

### About the IPEX Group of Companies

As leading suppliers of thermoplastic piping systems, the IPEX Group of Companies provides our customers with some of the largest and most comprehensive product lines. All IPEX products are backed by more than 50 years of experience. With state-of-the-art manufacturing facilities and distribution centers across North America, we have earned a reputation for product innovation, quality, end-user focus and performance.

Markets served by IPEX group products are:

- Electrical systems
- Telecommunications and utility piping systems
- Industrial process piping systems
- Municipal pressure and gravity piping systems
- Plumbing and mechanical piping systems
- Electrofusion systems for gas and water
- Industrial, plumbing and electrical cements
- Irrigation systems
- PVC, CPVC, PP, PVDF, PE, ABS, and PEX pipe and fittings

Sceptalight™ is manufactured by IPEX Electrical Inc.

Sceptalight™ is a trademark of IPEX Branding Inc.

This literature is published in good faith and is believed to be reliable. However it does not represent and/or warrant in any manner the information and suggestions contained in this brochure. Data presented is the result of laboratory tests and field experience.

A policy of ongoing product improvement is maintained. This may result in modifications of features and/or specifications without notice.



**IPEX**  
by **alixis**

BRELLFIP220401C  
© 2022 IPEX EL0028C

