



POCKET PRO



IPEX

by **alixis**

ELECTRICAL SYSTEMS

Scepter® Rigid PVC Conduit and Fittings

Scepter® JBox™ The Next Generation Junction Box

EPR Conduit Repair Kit

Sceptalight™ Nonmetallic Light Fixtures

Cor-Line® ENT and Kwikon® Electrical Nonmetallic Fittings

INEXO™ The ICF Box

Super Duct® Power and Communication Duct

MonoBloc® Underground Duct Spacers

SceptaCon™ Trenchless Raceway Systems

FiberTel® HDPE Innerduct

TYPE DESIGNATION	UL UNDERWRITERS LABORATORIES INC (UL 50 AND UL 508)
1	Indoor use primarily to provide protection against contact with the enclosed equipment and against a limited amount of falling dirt.
2	Indoor use to provide a degree of protection against limited amounts of falling water and dirt.
3	Outdoor use to provide a degree of protection against windblown rain; undamaged by the formation of ice on the enclosure.
4	Either indoor or outdoor use to provide a degree of protection against falling rain, splashing water, and hose-directed water; undamaged by the formation of ice on the enclosure.
4X	Either indoor or outdoor use to provide a degree of protection against falling rain, splashing water, and hose-directed water; undamaged by the formation of ice on the enclosure; resists corrosion.
6P	Indoor or outdoor use primarily to provide a degree of protection against hose-directed water, the entry of water during prolonged submersion at a limited depth, and be undamaged by the formation of ice on the enclosure.
12	Indoor use to provide a degree of protection against dust, dirt, fiber flyings, dripping water, and external condensation of noncorrosive liquids.
13	Indoor use to provide a degree of protection and spraying of water, oil, and noncorrosive liquids.

This material is reproduced with permission from Underwriters Laboratories Inc. Standard for Safety for Cabinets and Boxes, UL 50, Copyright 1988 and Industrial Control Equipment, UL 508, Copyright 1994 by Underwriters Laboratories Inc.

Underwriters Laboratories Inc. (UL) shall not be responsible to anyone for the use of or reliance upon a UL Standard by anyone. UL shall not incur any obligation or liability for damages, including consequential damages, arising out of or in connection with the use, interpretation of, or reliance upon a UL Standard.

Introduction	2
Applications	3
Advantages	4
Scepter® Rigid PVC Conduit	7
Installation	8
Expansion and Contraction	10
Conduit Dimensions	15
Scepter® PVC Conduit Fittings	19
Fittings	20
Cover Plates	37
Weatherproof Covers	39
Gang Boxes	41
Floor Box	43
Floor Box Cover Plates	45
Standard Junction Boxes	46
Conduit Cements & Primers	47
Scepter® JBox™	49
Conduit Repair Kit	54
EPR Kits	54
EPR Kit Adapters	54
Sceptralight™: Nonmetallic Light Fixtures	55
LED	57
Compact Fluorescent	58
Incandescent	59
Accessories	62
Options	63
Cor-Line® ENT & Kwikon® Fittings	65
Cor-Line Tubing	68
Dimensions	68
Kwikon Fittings	69
Kwikon Accessories	73
INEXO™	75
Super Duct®	77
Advantages/Engineering Data	78
Installation	79
Pipe	84
Fittings	85
Vertical-Lok Spacers	90
Monobloc® Spacers	92
SceptaCon™ Trenchless Raceway Systems	95
FiberTel® HDPE Innerduct	97



Pocket Pro provides the most comprehensive information about PVC systems – from basic raw material to installation characteristics of the finished product. Written with the engineer, contractor and distributor in mind, it is based on laboratory test results and IPEX's many years of field experience.

At IPEX, we have been extruding PVC conduit and molding fittings since 1951. We formulate our own compounds, maintain strict quality control during production, and offer one of the most comprehensive lines of nonmetallic electrical products throughout North America.

More important, our commitment to customers extends beyond the sale. Quality control and thorough jobsite field reports have earned IPEX a reputation for product quality and service excellence.

Engineers, electricians, contractors, specifiers and utilities have realized for many years the advantages of PVC. Today, IPEX electrical systems include Scepter® PVC conduit and fittings, Cor-Line® ENT, FiberTel® high density polyethylene innerduct, INEXO® ICF boxes, Kwikon® ENT fittings, Monobloc® spacers, SceptaCon™ trenchless raceway systems, Sceptalight™ nonmetallic light fixtures and Super Duct® power and communication ducts. These brands are the number-one choice for power, communication and data needs. Whether exposed, concealed in walls, encased in concrete, or directly buried, IPEX electrical products are preferred *For The Long Run*.

Only when you specify IPEX branded products by name are you guaranteed our commitment to excellence.

Applications

Typical industrial/commercial and residential applications for IPEX electrical systems include:

- Utilities
- Cable
- Communications
- Street and highway lighting
- Residential applications
- Water treatment plants
- Airports
- Subways
- Sewage treatment plants
- Pulp and paper industries
- Parking garages
- Car washes
- Fish plants
- Marinas
- Agricultural, dairy, hogs, cattle, chicken, etc.
- Bridges and tunnels
- Food processing plants
- Steel mills
- Mines



Labour Savings

Compared to metal, PVC products reduce labour on a typical installation by up to two-thirds. The reason? PVC is easy to work with. It can also be cut and joined without pipe vises, cutters, threading equipment and reamers associated with metal conduit.

Lightweight Conduit

Scepter Rigid PVC Conduit is one-half the weight of aluminum and one-sixth the weight of steel. As a result, handling and installation are easier and faster, reducing labour costs.

Sunlight Resistant

The 2011 Canadian Electrical Code rule 2-130 is intended to ensure that totally enclosed nonmetallic raceways are properly protected against adverse effects from direct exposure to UV rays. Electrical nonmetallic raceways marked for such applications are suitable for installation and use in direct exposure to the rays of the sun. Scepter rigid PVC Conduit meets the criteria for sunlight resistance, is approved for the purpose, and is appropriately marked.

Easy Joining

Solvent cementing is all that is required, eliminating the need for power-threading machines, pipe vises and cutting equipment. A hacksaw or carpenter's saw is the only equipment required.

Strength

Scepter Rigid PVC Conduit offers both high impact and high tensile strength, even in cold temperatures. Scepter Rigid PVC Conduit and Fittings meet and exceed all CSA and UL standards.

Scepter Rigid PVC Conduit		CSA Impact Test		UL Impact Test	
Size in	Size mm	@ -29°F (-34°C) ft.lbs.	joules	@ 72°F (23°C) ft.lbs.	joules
1/2	12	8.9	12	50	68
3/4	20	8.9	12	80	109
1	25	8.9	12	100	136
1 1/4	32	8.9	12	120	163
1 1/2	40	8.9	12	150	204
2	50	8.9	12	190	258
2 1/2	65	8.9	12	210	285
3 – 6	75 – 150	8.9	12	220	298

Easy Wire Pulls

PVC's exceptionally smooth interior surface greatly reduces the amount of friction while pulling conductors/wires through long runs, even with 90° bends. A large pull-rope and wire-pulling compound should be used when pulling all conductors and wires.

Noncorroding

PVC is immune to damage from naturally corrosive soil conditions, as well as electro-chemical and galvanic corrosion. This ensures lower maintenance costs and superior performance *For The Long Run*.

Nonconducting

Scepter Rigid PVC conduit pipe and fittings are nonsparking and nonconducting, thereby eliminating the most dangerous 'second point of contact' and 'phase to ground' faults. The use of a separate grounding conductor provides a complete and positive ground for the whole system.

Chemical Resistance

One of the greatest benefits of PVC is its excellent chemical resistance. It resists attack by acids, alkalies, salt solutions, and many other types of chemicals. For more information on PVC and chemical resistance, refer to the IPEX Chemical Resistance Guide.

Long Life

Scepter Rigid PVC Conduit pipe and fittings retain their original properties after years of exposure to heat and weather. In addition, resistance to fungi, bacterial action, rodents, termites and corrosive agents ensures a long, trouble-free life for PVC conduit installed indoors or outdoors.

Fire Resistant

As a building material PVC offers outstanding fire performance characteristics. PVC will not burn unless an external flame source is applied, and will not sustain ignition once the flame source is removed. PVC has a flash ignition temperature of 850°F.

Concrete Tight

Scepter Rigid PVC Conduit pipe and fittings are designed and engineered to be concrete tight in all weather conditions.

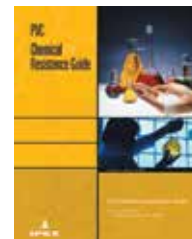

Fire Resistant

IPEX's proprietary PVC compound used to manufacture Scepter products is a self-extinguishing material and will not support combustion. Samples taken from an actual fire show the outer surface of the conduit was blistered and charred. The interior of the conduit, however, was unaffected. Additionally, the undamaged conductors were then removed and reinstalled in new conduit.

Fire-resistant characteristics when tested to CAN ULC S102.2 are as follows:

FT-4 Rating

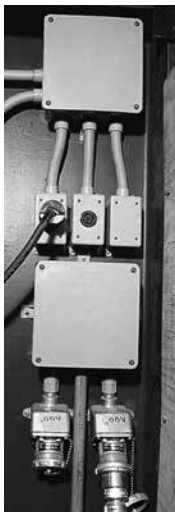

Scepter Rigid PVC conduit is certified to meet the requirements of FT-4 allowing its use in noncombustible construction per Section 3.1.5.20 of the National Building Code, which reads:

1.) *Subject to the limits on the size of elements that penetrate fire separations as stated in Sentence 3.1.9.3.(2), within a fire compartment of a building required to be of noncombustible construction, totally enclosed nonmetallic raceways not more than 175mm in outside diameter, or of an equivalent rectangular area, are permitted to be used to enclose optical fibre cables and electrical wires and cables, provided the raceways exhibit a vertical char not more than 1.5m when tested in conformance with the Vertical Flame Test (FT - 4) Conduit or Tubing on Cable Tray in Clause 6.16 of CSA C22.2 No. 211.0, "General Requirements and*

Methods of Testing for Nonmetallic conduit."

Suitable for Direct Burial

PVC is suitable for direct burial and requires no extra protection when installed in accordance with the Canadian Electrical Code and the local inspection authority guidelines. The usual care regarding trenches and backfilling should be respected.

One-Source Specification

IPEX offers a full range of PVC fittings and accessories. As a result, it is easy to specify a single source PVC system.

Quality Control

In addition to IPEX's quality control testing, all Scepter electrical products carry third-party certification by CSA, UL and NRTL.



This section covers the most comprehensive design and installation of Scepter Rigid PVC Conduit pipe and fittings. Always consult the authority having jurisdiction for specific installation procedures.



CSA C22.2 No. 211.2
CSA C22.2 No. 211.0
FT-4 for 1/2" to 6"



NEMA TC-2
Corps. of Engineers Spec.
CE 303:01
Military Spec, Federal
Spec.
WC 1094A

Support

Due to PVC's light weight, support spacing is different than that used with metal conduits. Supporting straps should NOT be firmly tightened, so that linear movement of the pipe is possible. The maximum allowable support spacing, as per Canadian Electrical Code (CEC), is as follows:

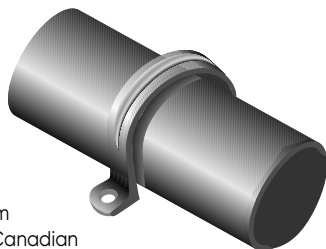

Support Spacing For Scepter Rigid PVC Conduit Pipe

Nominal Conduit Diameter		Maximum Support Spacing	
inches	mm	feet	metres
1/2	12	2-1/2	0.75
3/4	20	2-1/2	0.75
1	25	2-1/2	0.75
1-1/4	32	4	1.2
1-1/2	40	4	1.2
2	50	5	1.5
2-1/2	65	6	1.8
3	75	6	1.8
3-1/2	90	7	2.1
4	100	7	2.1
5	125	7	2.1
6	150	8	2.5

Maximum Operating Temperature

The Canadian Electrical Code (CEC) allows the use of Scepter Rigid PVC Conduit up to a maximum ambient temperature of 167°F (75°C).

Cutting

Scepter Rigid PVC conduit can be easily cut on the jobsite by using a hacksaw, carpenter's saw or PVC conduit cutters. For larger sizes of conduit, the use of a mitre box is also recommended to ensure a square cut.



Solvent Cementing

After cutting Scepter Rigid PVC conduit, sharp edges or burrs from inside the conduit should be removed with a knife. Thoroughly clean the end of the pipe and inside the fitting with a pipe cleaner. Apply a generous amount of IPEX solvent cement to both surfaces; slide together and give a quarter turn to ensure the solvent is spread evenly on the material. Hold together for a few seconds until the joint is made.

Usually the solvent-cemented joint will be strong enough to install immediately. However, in climates with low temperatures or areas with high humidity, extra time may be required before moving the pipe for permanent installation. Solvent-cemented joints appear to "set up" instantly, but will take 24 hours to cure properly. After this time, the solvent-cemented joint has completely cured and is waterproof. For extreme cold weather installations, the use of IPEX PVC Primer is recommended. IPEX cements and primers are available in quarter-pint (125ml), half-pint (250ml), pint (500ml), quart (1-litre) and gallon (4-litre) containers.

Bending

PVC is a thermoplastic material that, when heated, becomes soft and pliable. As a result, its shape can be altered.

A flameless heat source is recommended to heat the pipe. AN OPEN FLAME SHOULD NOT BE USED. Either an electric unit or an infra-red propane unit is recommended.

The necessary temperature for bending pipe is 260°F (127°C). The pipe must be heated evenly over an area approximately ten times the diameter of the pipe before any attempt at bending is made. Bending the pipe when it has not been thoroughly heated will cause the pipe to "kink." With proper care and a little practice, the bend will form easily.

Cooling the pipe with cold air or water will cause "spring back." Allow a few extra degrees of overbending to compensate. Maximum bending radius shall be six times the internal diameter according to the Canadian Electrical Code.



Using Expansion Joints

It's just as important to know when to use an expansion joint as it is to know how to install it correctly. Expansion joints are required when the temperature change is greater than 25°F (14°C). Scepter Rigid PVC conduit has a coefficient of linear expansion of 3.6×10^{-4} in./ft./°F (.054mm/m/°C.) Generally, a 100 ft. (30.48m) run of PVC conduit will undergo a change in length of 3.6 inches (91.44mm) for every 100°F (56°C) temperature change.



For conduit installed indoors, the range of expansion and contraction can be calculated using the maximum air temperature plus the heat contributed by the conductors inside the conduit and minimum air temperature expected. Expansion joints are not required indoors unless there are widely varying temperatures such as the attic of a building.

Conduit installed outdoors, exposed to direct sunlight, will be considerably hotter than the air temperature. As a guideline in this case, add 27°F (15°C) to the temperature change. Expansion joints should be installed to allow for all anticipated temperature changes.

Expansion Formula

By using the following formulas and the charts below, the total expected expansion in a run can be easily determined:

°F
 Total Expansion (in.)
 = length of run (ft.)
 x temperature change
 (°F) x 0.00036

or

°C
 Total Expansion (mm)
 = length of run (m)
 x temperature change
 (°C) x 0.054

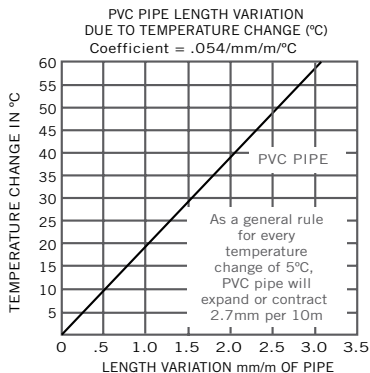
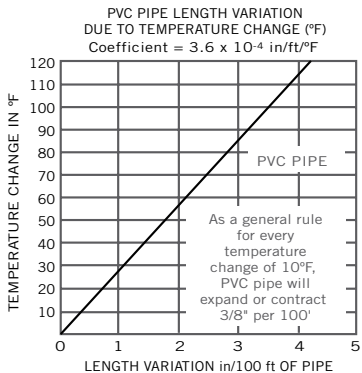

Number of Expansion Joints Required

Use the following equation to determine the number of expansion joints needed for a Scepter Rigid PVC Conduit installation:

$$\text{Number of joints} = \frac{\text{total expansion (mm or in)}}{E}$$

E = Expansion joint travel length 101.6mm (4") or 203.2mm (8") depending on diameter.

Always round up to the next whole number.

Setting the Piston Opening

The expansion joint must be installed to allow for expansion and contraction of the conduit run. On a cold day, if an expansion joint is installed completely closed with the piston bottomed, there is no room for expansion when the conduit is warmed. If it is installed open to the maximum on a hot day, the expansion joint will pull apart when cooled.

The correct piston opening for any installation condition can be easily determined using the formula below:

Piston setting =
 Compressed length + $\left(\frac{\text{max. temp.} - \text{installation temp.}}{\text{max. temp.} - \text{min. temp.}} \right) \times E$

Formula can be used for both metric and imperial measurements.

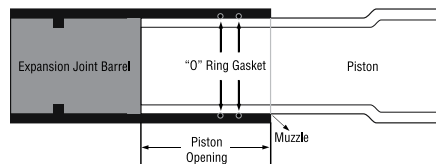

Size	Compressed Length		Travel		
	(mm)	(in)	(mm)	(in)	
13	1/2	203.2	8.00	101.6	4
20	3/4	203.2	8.00	101.6	4
25	1	215.9	8.50	101.6	4
32	1-1/4	228.6	9.00	101.6	4
38	1-1/2	228.6	9.00	101.6	4
51	2	235.0	9.25	101.6	4
64	2-1/2	362.0	14.25	203.2	8
76	3	362.0	14.25	203.2	8
89	3-1/2	378.5	14.90	203.2	8
102	4	378.5	14.90	203.2	8
127	5	660.4	26.00	203.2	8
152	6	660.4	26.00	203.2	8

Location of Expansion Joints

Proper functioning of an expansion joint depends on three procedures:

1. The correct placement of the expansion joint.
2. The proper installation of Scepter Rigid PVC conduit and the expansion joint.
3. The proper placement and fastening of support straps.

One Expansion Joint

Figure 1

If only one expansion joint is needed between two boxes, the barrel of the joint is rigidly fastened close to the first box. Scepter Rigid PVC conduit should then be loosely supported with straps, allowing the conduit to move freely as it expands and contracts.

Two Expansion Joints

Figure 2

If two expansion joints are needed, the joints should be firmly fastened back to back at the centre of the run. Scepter Rigid PVC conduit is loosely supported with straps, allowing the conduit to move freely as it expands and contracts.

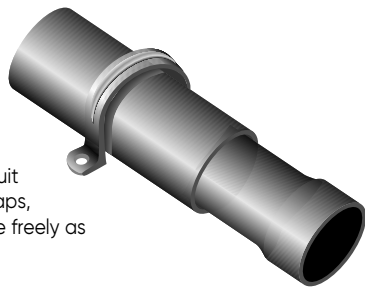

Two Expansion Joints (Alternative)

Figure 3

Alternatively, the centre of the run and the two expansion joints (located at the boxes) should be rigidly fastened. All other support straps should be loosely fastened.

Three or More Expansion Joints

Figure 4

If more than two joints are needed in a very long run, they should be put in a series, one after the other. Each barrel must be rigidly fastened while conduit is loosely supported with straps allowing the conduit to move freely as it expands and contracts. When installed in a series, each section acts independently of the other. Spacing of conduit supports must be in accordance with Section 12-1114 of the Canadian Electrical Code (CEC).

Figure 1

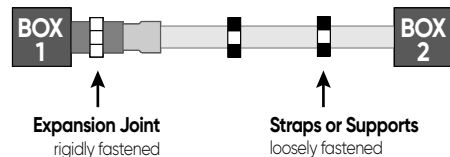

Figure 2

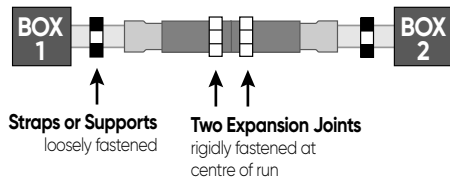

Figure 3

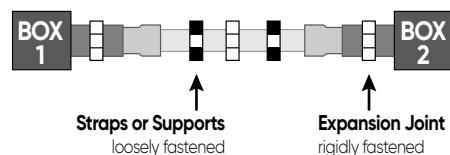
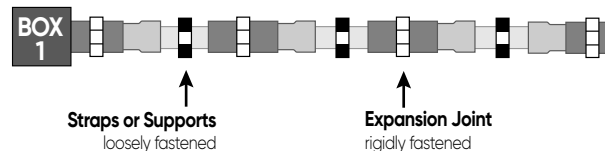

Figure 4



Legend

- : Guide or Hanger
- : Anchor

Installation of Expansion Joints

Installation recommendations:

- Expansion joints should be mounted so the piston can travel in a straight line in the barrel. If the alignment is not straight, the piston will bind, preventing the joint from functioning correctly.
- The expansion joint barrel should be clamped tight, but the conduit mounted loose enough in its hangers to allow for movement as it expands and contracts.
- Scepter nonmetallic straps are correctly sized and designed for proper support, and must be used to secure the conduit.
- When expansion joints are used in a vertical position, the piston should be mounted in a downward position so dirt cannot deposit between the barrel and piston at the muzzle of the expansion joints.

WARNING

Common Mistakes

Three common mistakes are:

1. Forgetting to use expansion joints.
2. Not using enough expansion joints.
3. Overtightening of support straps.

It is more cost effective to use more expansion joints than needed, rather than too few. It is difficult to correct the problem after conductors are installed and in service. Failure to accommodate expansion/contraction may result in pipe fracture.

Scepter Rigid PVC Conduit Dimensions (inches)

Nominal Size	Product Code	OD	ID	Min. Wall	Weight lbs/100'	Standard ft/crate
1/2	(10') 032105	0.840	0.622	0.109	15	6,000
	(20') 032106					12,000
3/4	(10') 032107	1.050	0.824	0.113	21	4,400
	(20') 032108					8,800
1	(10') 032110	1.315	1.049	0.133	31	3,600
	(20') 032111					7,200
1-1/4	(10') 032112	1.660	1.380	0.140	42	3,300
	(20') 032114					6,600
1-1/2	(10') 032115	1.900	1.610	0.145	53	2,250
	(20') 032116					4,500
2	(10') 032120	2.375	2.067	0.154	71	1,400
	(20') 032121					2,800
2-1/2	(10') 032125	2.875	2.469	0.203	112	780
	(20') 032126					1,560
3	(10') 032130	3.500	3.068	0.216	166	780
	(20') 032131					1,560
3-1/2	(10') 032135	4.000	3.548	0.226	200	630
	(20') 032136					1,260
4	(10') 032140	4.500	4.026	0.237	236	600
	(20') 032141					1,200
5	(10') 032150	5.563	5.047	0.258	321	230
	(20') 032151					460
6	(10') 032160	6.625	6.065	0.280	417	260
	(20') 032161					520
8	(10') 032180	8.620	7.980	0.322	559	140
	(20') 032181					280

Scepter Rigid PVC Conduit Dimensions (mm)

Nominal Size	OD	ID	Min. Wall	Weight kgs/100'
12	21.3	15.8	2.8	22.6
20	26.7	20.9	2.9	31.2
25	33.4	26.6	3.4	46.2
32	42.2	35.1	3.6	63.0
40	48.3	40.9	3.7	78.4
50	60.3	52.5	3.9	105.5
65	73.0	62.7	5.2	167.2
75	88.9	77.9	5.5	247.8
90	101.6	90.1	5.7	297.7
100	114.3	102.3	6.0	352.4
125	141.3	128.2	6.6	478.5
150	168.3	154.1	7.1	621.0
200	219.0	202.6	8.18	833.1

Weight Comparison of Scepter Rigid PVC Conduit - lbs./100 ft.

Nominal Size (in)	Rigid PVC	Aluminum	Rigid Steel
1/2	15	28	79
3/4	21	27	105
1	31	53	153
1-1/4	42	70	201
1-1/2	53	86	249
2	71	116	334
2-1/2	112	183	527
3	166	239	690
3-1/2	200	288	831
4	236	340	982
5	321	465	1,334
6	417	613	1,771
8	559		

Weight Comparison of Scepter Rigid PVC Conduit - kg/100 m

Nominal Size (in)	Rigid PVC	Aluminum	Rigid Steel
12	23	41	118
20	31	54	157
25	46	79	228
32	63	104	300
40	78	129	371
50	106	173	498
65	167	272	786
75	248	356	1,029
90	298	429	1,239
100	352	507	1,464
125	479	694	1,989
150	621	914	2,641
200	833		



CSA C22.2 No. 211.2
FT-4 for 1/2" to 6"



NEMA TC2
Corps. of Engineers Spec.
CE 303:01
Military Spec, Federal Spec.
WC 1094A

Physical properties of PVC Type II

Properties	Unit	Value	ASTM Test Method
Electrical			
Dielectric Strength	volts/mil	1215	D149
Dielectric Constant	60 cps at 30°C	3.55	D150
	1000 cps at 30°C	3.22	D150
Power Factor	60 cps at 30°C	4.04	D150
	1000 cps at 30°C	4.71	D150
Physical			
Specific Gravity		13.5	D792
Hardness	Durometer D	78	D676
Izod Impact Strength @ 73°F (23°C)	ft.lb/in. notch	15.0	D256
Tensile Strength @ 73°F (23°C)	psi	6000	D638
Compressive Strength	psi	8600	D695
Flexural Strength	psi	11500	D790
Thermal			
Coefficient of Thermal Conductivity	BTU/sec/in ² /°F/in	0.11	C177
Coefficient of Linear Expansion	per °F x 10 ⁻⁵	5.5	D696
Heat Distortion Temperature at 264 psi	°F	158	D648
Others			
Flammability		self-extinguishing	D635
Water Absorption in 30 days	%	0.6	
Color		charcoal grey	
Light Transmission		opaque	D791

All technical data is believed to be accurate and is presented solely for information and guidance.



The **SCEPTER APP** for Electrical Contractors

A digital solution to calculate the required number of joints or recommended support spacing in seconds.



Industry leaders specify Scepter PVC fittings by name. For years, Scepter PVC fittings have set the standard for quality and value-added features not normally available from other suppliers. Features such as our threaded brass inserts, brass screws, and superior PVC gasketing system make a real difference.



C22.2 No. 85
C22.2 No. 18.2



UL Listed
UL514B – UL514C



NEMA TC-2, 3

If you need more details about a specific product certification, please contact our customer service department.

Couplings

Size (in)	Part Number	Product Code	A (in)	B (in)	C (in)
1/2	EC10	077001	1.08	0.84	1.44
3/4	EC15	077002	1.30	1.05	2.20
1	EC20	077003	1.59	1.32	2.03
1-1/4	EC25	077004	2.00	1.66	2.16
1-1/2	EC30	077005	2.23	1.90	2.28
2	EC35	077006	2.72	2.38	2.41
2-1/2	EC40	077007	3.32	2.88	3.19
3	EC45	077008	4.00	3.50	3.44
3-1/2	EC50	077009	4.50	4.00	3.63
4	EC55	077010	5.00	4.50	3.75
5	EC60	077011	6.12	5.56	4.19
6	EC65	077012	7.37	6.63	4.56
8	EC70	077866	9.30	8.66	8.25

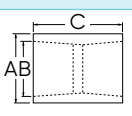

Repair Coupling Sleeves

Size (in)	Part Number	Product Code	A (in)	D Min (in)	D Max (in)
2	REC35	277293	6.50	2.37	2.40
3	REC45	277295	6.50	3.51	3.52
4	REC55	277296	8.00	4.51	4.52
5	REC60	277297	8.00	5.58	5.60
6	REC65	277298	8.00	6.64	6.67

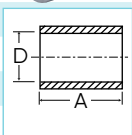

Neoprene O-Ring*

Size (in)	Part Number	Product Code
1/2	E943DX	077033
3/4	E943EX	077034
1	E943FX	077035
1-1/4	E943GX	077036
1-1/2	E943HX	077037
2	E943JX	077038
3	E943LX	077040
4	E943NX	077058



* For use with TA to obtain a water-tight seal.

Terminal Adapters

Size (in)	Part Number	Product Code	A (in)	B (in)	C (in)	D (in)
1/2	TA10	077021	0.70	0.59	0.75	1.55
3/4	TA15	077022	0.68	0.79	1.00	1.75
1	TA20	077023	0.63	1.00	1.12	1.86
1-1/4	TA25	077024	0.64	1.31	1.30	2.13
1-1/2	TA30	077025	0.73	1.53	1.43	2.25
2	TA35	077026	0.80	1.97	1.15	2.10
2-1/2	TA40	077027	0.80	2.35	1.90	2.93
3	TA45	077028	0.82	2.92	2.00	3.06
3-1/2	TA50	077029	1.00	3.39	1.72	3.06
4	TA55	077030	0.82	3.85	1.99	3.22
5	TA60	077031	1.73	5.02	2.00	5.99
6	TA65	077032	1.88	6.03	2.13	6.50

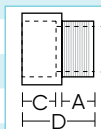

Note: 1/2" to 1-1/4" TA – tapered thread.
1-1/2" to 6" TA – non-tapered thread.

Female Adapters

Size (in)	Part Number	Product Code	A (in)	B (in)	C (in)	D (in)
1/2	FA10	077041	0.62	1.08	0.800	1.73
3/4	FA15	077042	0.82	1.30	0.800	1.90
1	FA20	077043	1.07	1.59	1.000	2.30
1-1/4	FA25	077044	1.40	2.00	1.015	2.43
1-1/2	FA30	077045	1.58	2.23	1.050	2.44
2	FA35	077046	2.05	2.72	1.075	2.55
2-1/2	FA40	077047	1.02	3.25	1.500	2.70
3	FA45	077048	3.09	4.00	1.630	4.10
3-1/2	FA50	077049	3.54	4.50	1.800	3.90
4	FA55	077050	4.03	5.00	1.755	4.21
5	FA60	077051	5.04	6.12	2.065	5.24
6	FA65	077052	6.05	7.37	2.065	5.24

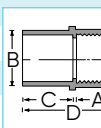

Note: All female adapters have NPT-tapered threads.

5° Couplings

Size (in)	Part Number	Product Code	L (in)
2	5EC35	077100	4.0
2-1/2	5EC40	077101	5.5
3	5EC45	077103	6.0
3-1/2	5EC50	077102	7.0
4	5EC55	277092	7.0
5	5EC60	277093	7.5
6	5EC65	077106	11.0

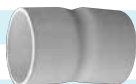
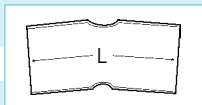

Threaded Reducer Bushings

Size (in)	Part Number	Product Code
3/4 x 1/2	1825	077314
1 x 1/2	1826	077315
1 x 3/4	1827	077316

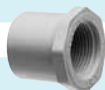

Reducer Bushings

Size (in)	Part Number	Product Code
3/4 x 1/2	1805	077300
1 x 1/2	1805-1	077301
1 x 3/4	1806	077302
1-1/4 x 3/4	1807-1	077303
1-1/4 x 1	1807	077304
1-1/2 x 1	1808-1	077305
1-1/2 x 1-1/4	1808	077306
2 x 1	1809-1	077313
2 x 1-1/4	1809	077307
2 x 1-1/2	1810	077308
2-1/2 x 2	1811	077309
3 x 2	1812-1	077310
3 x 2-1/2	1812	077311
4 x 2	1813-1	077319
4 x 3	1813	077312
4 x 3-1/2	1814	077317

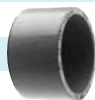

*Additional sizes of reducer bushings are available upon request.

End Caps

Size (in)	Part Number	Product Code
1/2	CAP10	077421
3/4	CAP15	077422
1	CAP20	077423
1-1/4	CAP25	077424
1-1/2	CAP30	077425
2	CAP35	077426
2-1/2	CAP40	077427
3	CAP45	077428
3-1/2	CAP50	277085
4	CAP55	077430
5	CAP60	077431
6	CAP65	077432
8	CAP80	077657



One Piece Expansion Joints (OPEJ)

Size (in)	Part Number	Product Code	A dia. (in)	2	3	Overall Length
1/2	OPEJ10	077018	1.102	0.660	2.465	3.25
3/4	OPEJ15	077019	1.314	0.729	2.646	3.50
1	OPEJ20	077053	1.610	0.885	2.725	3.75
1-1/4	OPEJ25	077054	1.987	0.950	2.895	4.00
1-1/2	OPEJ30	077061	2.208	1.075	3.030	4.25
2	OPEJ35	077063	2.701	1.140	3.206	4.50



"O" Ring Expansion Joints

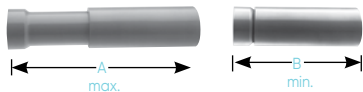

Size (in)	Part Number	Product Code	A (in) max.	B (in) min.
1/2	EJ10	277156	12.00	8.00
3/4	EJ15	077382	12.00	8.00
1	EJ20	077383	12.50	8.50
1-1/4	EJ25	077384	13.00	9.00
1-1/2	EJ30	077385	13.00	9.00
2	EJ35	077386	13.25	9.25
2-1/2	EJ40*	077387	22.25	14.25
3	EJ45	077388	22.25	14.25
3-1/2	EJ50	077389	22.25	14.25
4	EJ55	077390	22.25	14.25
5	EJ60	077391	22.25	14.25
6	EJ65	077392	22.25	14.25

* is a 3" EJ45 with reducer bushings

Make the RIGHT Choice!

Depend on IPEX for quality products & superior service

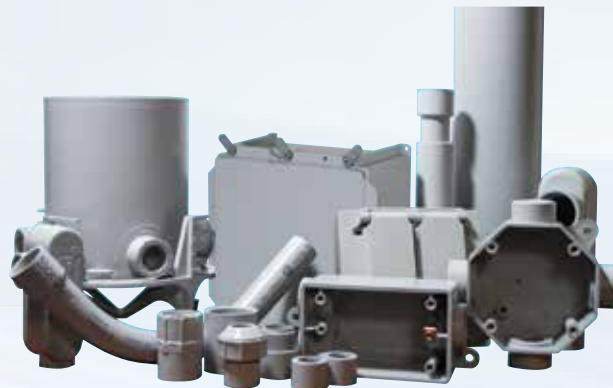

Scepter® Rigid Pipe and Fittings

Features and Benefits:

- Smooth interior surface reduces friction during wire pull
- Extensive product offering including boxes, fittings, couplings and elbows
- High impact & tensile strength
- Concrete-tight in all weather conditions

Expansion and Deflection Fitting Assemblies



Size (in)	Part Number	Description	Product Code
2*	SE-J-35	Complete Assembly	077889
3*	SE-J-45	Complete Assembly	077890
4*	SE-J-55	Complete Assembly	077891

*Not CSA Certified

Utility 90° Elbows c/w Solvent Bell End (Bell End x Plain End)

Size (in)	Part Number	Product Code	D (in)	T (in)	R (in)
2	NSL 2-24	069257	2.375	41.20	24
2	NSL 2-36	069260	2.375	31.70	36
3	NSL 3-24	069265	3.500	41.20	24
3	NSL 3-36	069261	3.500	31.70	36
4	NSL 4-36	069267	4.500	31.70	36
4	NSL 4-48	069266	4.500	22.25	48
5	NSL 5-36	069263	5.563	31.70	36
6	NSL 6-36	069264	6.625	31.70	36

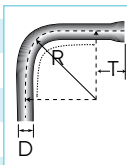

90° Elbows c/w Solvent Bell End (Bell End x Plain End)

Size (in)	Part Number	Product Code	D (in)	T (in)	R (in)
1/2	EE1090	069081	0.840	1.500	4.00
3/4	EE1590	069082	1.050	1.500	4.50
1	EE2090	069083	1.315	1.875	5.75
1-1/4	EE2590	069084	1.660	2.000	7.25
1-1/2	EE3090	069085	1.900	2.000	8.25
2	EE3590	069086	2.375	2.000	9.50
2-1/2	EE4090	069087	2.875	3.000	10.50
3	EE4590	069088	3.500	3.125	13.00
3-1/2*	EE5090	069089	4.000	3.250	15.00
4	EE5590	069090	4.500	3.375	16.00
5	EE6090	069091	5.563	3.625	24.00
6	EE6590	069092	6.625	3.750	30.00
8*	EE7090	069099	8.622	8.300	48.00

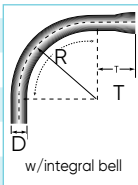

* Plain End x Plain End only

45° Elbows c/w Solvent Bell End (Bell End x Plain End)

Size (in)	Part Number	Product Code	D (in)	T (in)	R (in)
1/2	EE1045	069201	0.840	1.500	4.00
3/4	EE1545	069202	1.050	1.500	4.50
1	EE2045	069203	1.315	1.875	5.75
1-1/4	EE2545	069204	1.660	2.000	7.25
1-1/2	EE3045	069205	1.900	2.000	8.25
2	EE3545	069206	2.375	2.000	9.50
2-1/2	EE4045	069207	2.875	3.000	10.50
3	EE4545	069208	3.500	3.125	13.00
3-1/2*	EE5045	069209	4.000	3.250	15.00
4	EE5545	069210	4.500	3.375	16.00
5	EE6045	069211	5.563	3.625	24.00
6	EE6545	069212	6.625	3.750	30.00
8*	EE7045	069213	8.622	8.300	48.00

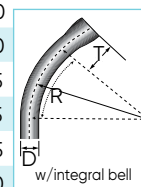

* Plain End x Plain End only

30° Elbows (Plain End x Plain End)

Size (in)	Part Number	Product Code	D (in)	T (in)	R (in)
1/2	EE1030	069241	0.840	1.500	4.00
3/4	EE1530	069242	1.050	1.500	4.50
1	EE2030	069243	1.315	1.875	5.75
1-1/4	EE2530	069244	1.660	2.000	7.25
1-1/2	EE3030	069245	1.900	2.000	8.25
2	EE3530	069246	2.375	2.000	9.50
2-1/2	EE4030	069247	2.750	3.000	10.50
3	EE4530	069248	3.500	3.125	13.00
3-1/2	EE5030	069249	4.000	3.250	15.00
4	EE5530	069250	4.500	3.375	16.00
5	EE6030	069251	5.563	3.625	24.00
6	EE6530	069252	6.625	3.750	30.00
8	EE7030	069254	8.622	8.300	48.00

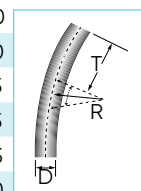

90° Elbows Extended bend (Bell End x Plain End)

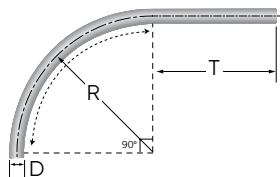

Size (in)	Part Number	Product Code	D (in)	T (in)	T2 (in)	R (in)
1-1/4	EE2590E	069096	1.66	10.24	4.53	6.73
1-1/2	EE3090E	069097	1.90	12.80	2.56	8.25
2	EE3590E	069098	2.38	11.02	2.74	13.00

Pipe Straps PVC, 2 Hole

Size (in)	Part Number	Product Code
1/2	PS10	077811
3/4	PS15	077812
1	PS20	077813
1-1/4	PS25	077814
1-1/2	PS30	077815
2	PS35	077816



Polyethylene (PE), 2 Hole

Size (in)	Part Number	Product Code
2-1/2	PS40	077262
3	PS45	077263
4	PS55	077264



PVC Coated Steel, 2 Hole

Size (in)	Part Number	Product Code
2	CS35	077818
2-1/2	CS40	077819
3	CS45	077820
3-1/2	CS50	077821
4	CS55	077822
5	CS60	077824
6	CS65	077823



PVC Coated Steel, 1 Hole

Size (in)	Part Number	Product Code
1/2	CS10-1	077831
3/4	CS15-1	077832
1	CS20-1	077833
1-1/4	CS25-1	077834
1-1/2	CS30-1	077835
2	CS35-1	077836
3	CS45-1	077838
3-1/2	CS50-1	077839
4	CS55-1	077840



Conduit Clamps & Spacers

Size (in)	Part Number	Product Code	X (in)	Y (in)	Z (in)
1/2	CCS10	077794	1.19	2.41	1.82
3/4	CCS15	077796	1.20	2.66	2.11
1	CCS20	077797	1.22	2.96	2.44
1-1/4	CCS25	077798	1.18	3.30	2.86
1-1/2	CCS30	077799	1.19	3.60	3.17
2	CCS35	077800	1.20	4.14	3.79
Strut Base	CCS-B	077343	-	-	-



* CCS-B are sold individually, two pieces are required to create one base unit.

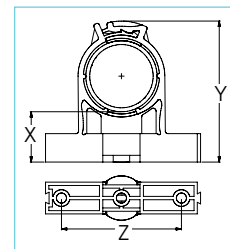

"Two in One" Pull Elbow

The "two in one" access pull elbow reduces inventory costs & increases installation flexibility (3/4" hub fitting supplied with 3/4" x 1/2" reducers). The pull elbow is approved for wet location use and is manufactured from high impact, nonconducting and noncorroding PVC.

Size (in)	Part Number	Product Code
1/2 or 3/4	PE15/10	077491

Access Fitting Dimensions



TYPE LL TYPE T TYPE TB TYPE LB TYPE E TYPE C TYPE LR

Size (in)	A (in)	B (in)	C (in)	D (in)	E (in)	F (in)
1/2	5.6	0.6	1.3	1.1	0.8	4.3
3/4	5.6	0.8	1.5	1.3	1.1	5.4
1	6.5	0.9	1.7	1.6	1.3	6.3
1-1/4	7.9	1.1	2.3	2.0	1.7	7.6
1-1/2	8.5	1.1	2.7	2.3	1.9	8.3
2	10.9	1.2	3.2	2.8	2.4	10.5
2-1/2	14.6	1.8	4.5	4.0	2.9	13.6
3	14.6	1.9	4.5	4.0	3.5	13.6
3-1/2	17.0	2.1	5.5	5.0	4.0	16.0
4	17.0	2.1	5.5	5.0	4.5	16.0

Size (in)	G (in)	H (in)	I (in)	J (in)	K (in)	L (in)
1/2	4.1	1.3	2.5	2.3	1.0	0.8
3/4	4.1	1.3	2.5	2.8	1.0	0.8
1	4.8	1.5	2.1	3.3	1.1	1.1
1-1/4	5.8	1.8	3.6	4.0	1.6	1.0
1-1/2	6.5	1.8	3.9	4.3	1.7	1.1
2	8.2	2.3	4.5	5.4	2.0	1.2
2-1/2	9.8	3.8	6.2	7.3	2.6	-
3	10.9	2.7	6.2	7.3	2.6	-
3-1/2	11.5	4.5	7.5	8.5	3.0	-
4	11.5	4.5	7.5	8.5	3.0	-

All access fittings are CSA and UL listed for wet locations.
Supplied with threaded brass inserts, combination brass head screws, PVC gasket & cover.

Access Fittings Type LL

Size (in)	Part Number	Product Code
1/2	SLL10S	077521
3/4	SLL20S	077522
1	SLL30S	077523
1-1/4	SLL40S	077524
1-1/2	SLL50S	077525
2	SLL60S	077526
2-1/2	SLL70S	077527
3	SLL80S	077528
3-1/2	SLL90S	077530
4	SLL100S	077529

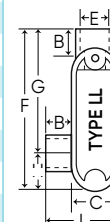

Access Fittings Type T

Size (in)	Part Number	Product Code
1/2	ST10S	077461
3/4	ST20S	077462
1	ST30S	077463
1-1/4	ST40S	077464
1-1/2	ST50S	077465
2	ST60S	077466
2-1/2	ST70S	077467
3	ST80S	077468
3-1/2	ST90S	077471
4	ST100S	077572

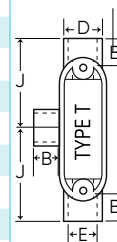

Access Fittings Type TB

Size (in)	Part Number	Product Code
1/2	STB10S	077451
3/4	STB20S	077452
1	STB30S	077453
1-1/4	STB40S	077454
1-1/2	STB50S	077455
2	STB60S	077456

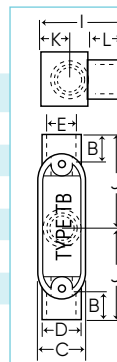

All access fittings are CSA and UL listed for wet locations.
Supplied with threaded brass inserts, combination brass head screws, PVC gasket & cover.

Access Fittings Type LB

Size (in)	Part Number	Product Code
1/2	SLB10S	077541
3/4	SLB20S	077542
1	SLB30S	077543
1-1/4	SLB40S	077544
1-1/2	SLB50S	077545
2	SLB60S	077546
2-1/2	SLB70S	077547
3	SLB80S	077488
3-1/2	SLB90S	077549
4	SLB100S	077550



Access Fittings Type E

Size (in)	Part Number	Product Code
1/2	SE10S	077561
3/4	SE20S	077562
1	SE30S	077563
1-1/4	SE40S	077564
1-1/2	SE50S	077565
2	SE60S	077566
2-1/2	SE70S	077567



Access Fittings Type C

Size (in)	Part Number	Product Code
1/2	SC10S	077501
3/4	SC20S	077502
1	SC30S	077503
1-1/4	SC40S	077504
1-1/2	SC50S	077505
2	SC60S	077506
2-1/2	SC70S	077507
3	SC80S	077508
3-1/2	SC90S	077510
4	SC100S	077509

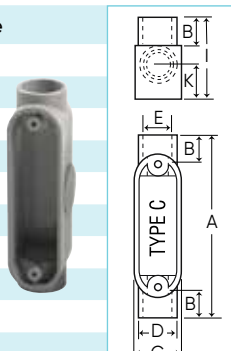

All access fittings are CSA and UL listed for wet locations.
Supplied with threaded brass inserts, combination brass head screws, PVC gasket & cover.

Access Fittings Type LR

Size (in)	Part Number	Product Code
1/2	SLR10S	077481
3/4	SLR20S	077482
1	SLR30S	077483
1-1/4	SLR40S	077484
1-1/2	SLR50S	077485
2	SLR60S	077486
2-1/2	SLR70S	077480
3	SLR80S	077488
3-1/2	SLR90S	077487
4	SLR100S	077489



End Bells

Size (in)	Part Number	Product Code
1/2	EB10	077406
3/4	EB15	077085
1	EB20	077323
1-1/4	EB25	077324
1-1/2	EB30	077325
2	EB35	077326
2-1/2	EB40	077327
3	EB45	077328
3-1/2	EB50	077329
4	EB55	077330
5	EB60	077331
6	EB65	077332
8	EB80	277094



Service Entrance Fittings

Size (in)	Part Number	Product Code
1/2	EF10	077281
3/4	EF15	077282
1	EF20	077283
1-1/4	EF25	077284
1-1/2	EF30	077285
2	EF35	077286
2-1/2	EF40	077287
3	EF45	077288
3-1/2	EF50	077289
4	EF55	077290



Meter Offsets

Size (in)	Part Number	Product Code
1-1/4	MO25	077941
2	MO35	077942
2-1/2	MO40	277084



Meter Hubs

Size (in)	Part Number	Product Code
1-1/4	MHU25	077961
1-1/2	MHU30	077963
2	MHU35	077965
2-1/2	MHU40	077967
3	MHU45	077968



Scepter® 2 1/2 inch Meter Offset

- Accommodates aluminum wire bond and 200A services
- Allows connection to meter hub without use of a reducer
- Offsets pipe to easily enable connections to junction and meter boxes
- Watertight connections



» Discover Scepter®

IPEX
by *alialix*

Long Meter Offsets (Fabricated)

Size (in)	Part Number	Product Code
1-1/4	LMO25	069641
1-1/2	LMO30	069645
2	LMO35	069646

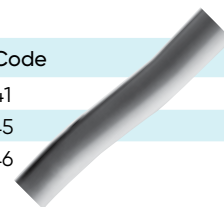

Scepter PVC Expansion Joints (c/w TA fitting)

Size (in)	Part Number	Product Code
2	EJ35TA	077680
2-1/2	EJ40TA	077398
3	EJ45TA	077681
4	EJ55TA	077682

Scepter Slip Meter Risers (c/w TA fitting)

Size (in)	Part Number	Product Code
2	SMR20TA	068063
2-1/2	SMR25TA	068064
3	SMR30TA	068373
4	SMR40TA	068065



Slip Meter Risers allow the underground PVC service conduit to 'slip' inside the fitting and thus account for ground movement. The factory assembled SMR fitting is supplied with a male adapter, is 2 feet in length and is sized to accept the underground raceway (i.e. 2" underground service conduit requires a 2" SMR). The SMR fitting must be installed with the open barrel end towards the ground.

Nonmetallic Threaded Strain Relief Connector c/w "O" Ring, Locknut & 4 Grommets

The Strain Relief Connectors come with everything needed to make a cable connection. The package includes a connector body, cap, and grommets that cover a wide range of cable types and sizes to provide added flexibility on the jobsite.

These specially designed grommets have collapsing teeth and an inverting membrane which secures cables and provides exceptional strain relief at termination points. The grommets are made from a specially formulated TPE material that provides exceptional grip and durability.



Size (in)	Configuration	Part Number	Product Code	
			NEW	OLD
1/2	Threaded	TSRC10A	277081	077754
3/4	Threaded	TSRC15A	277079	077756
3/4	Solvent Cement	SRC15A	277080	077985

Strain Relief Connectors Grommet Dimensions



Round Small Grommet
0.335" to 0.395"



Round Medium Grommet
0.395" to 0.495"



Round Large Grommet
0.495" to 0.575"



Oval Large Grommet
0.451" to 0.225" to 0.585" x 0.282"

F Series - Single Gang Plates



Description	Part Number	Product Code
Duplex Receptacle	DRC15/10	077617
Toggle Switch	TSC15/10	077616
Single Receptacle	20RC15/10	077618
Single Receptacle	20-3RC15/10	077619
Single Receptacle	30RC15/10	077620
Blank c/w Gasket	BRC15/10	077611
PVC Gasket	GASK15/10	077621

F Series - Double Gang Plates - OLD Style



Description	Part Number	Product Code
Blank Cover c/w Gasket	BRC20-2	077614
Double Switch	TSC20-2	077738
Double Duplex Receptacle	DRC20-2	077740
Combo Switch Duplex Rec.	TSDC20-2	077739
PVC Gasket	GASK20-2	077743

F Series - Universal Double Gang Plates - NEW Style *(only fits new style double gang boxes)*

see next page

F Series - Universal Double Gang Plates – NEW Style

(only fits new style double gang boxes)

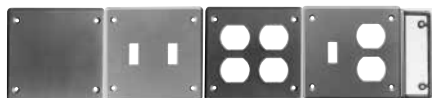

BRCU20-2 TSCU20-2 DRCU20-2 TSDCU20-2 GASKFU20-2

Description	Part Number	Product Code
Blank Cover c/w Gasket	BRCU20-2	077359
Double Switch	TSCU20-2	077373
Double Duplex Receptacle	DRCU20-2	077362
Combo Switch Duplex Receptacle	TSDCU20-2	077374
PVC Gasket	GASKFU20-2	172650

F Series - Triple Gang Plates



BRC20-3 DRC20-3 DSDR20-3 TSC20-3 TSDC20-3

Description	Part Number	Product Code
Triple Receptacle	DRC20-3	077747
Combo Switch Receptacle	DSDR20-3	077745
Triple Switch	TSC20-3	077744
Combo Switch Receptacle	TSDC20-3	077746
Blank Cover c/w Gasket	BRC20-3	077748
PVC Gasket	GASK20-3	077749

Weatherproof Covers - Single Gang

	Description	(in)	Part Number	Product Code
VPT15/10 	Plunger-style Switch Cover		VPT15/10	077630
VSC15/10 	Toggle Switch Cover		VSC15/10	077612
WTG15/10 	Grey Toggle Switch Cover		WTG15/10	077606
WDR15/10 RWDR15/10 	Grey Duplex Receptacle		WDR15/10	077993
	White Duplex Receptacle		RWDR15/10	077786
WGF15/10 RWGF15/10 	Grey Ground Fault Receptacle		WGF15/10	077785
	White Ground Fault Receptacle		RWGF15/10	077787
WTL15 WTL20 WTL30 	Single Receptacle Device 15 AMP	1.375	WTL15	077992
	Single Receptacle Device 20 AMP	1.625	WTL20	077994
	Single Receptacle Device 30 AMP	1.722	WTL30	077991
	Single Receptacle Device 50 AMP	2.187	WTL50	077951
WDRE15/10 RWDR15/10 	Grey Double Door Duplex Receptacle		WDRE15/10	077087
	White Double Door Duplex Receptacle		RWDR15/10	077408
WDR15/10 RWDR15/10	Gasket for W Series Cover (except WDRE & RWDR)		GASKW	077755
	Gasket for WDRE & RWDR Covers		GASKDD	072225

Note:

Weatherproof covers, with lids closed, are CSA and UL Listed for wet locations.

Weatherproof Covers - Double Gang - OLD Style

Description	Part Number	Product Code
Toggle Switch Cover	VSC20-2	077741
Combination Switch & GFI Receptacle	VSRC20-2	077742
Combination Switch & Duplex Receptacle	VSDR20-2	077752
Combination Switch & Single Receptacle Cover	VSRR20-2	077753
Double Door GFCI Cover	VSGG20-2	077096
Double Door Duplex Cover	VSDD20-2	077097
Gasket for 2-Gang 'F' Boxes (except VSGG20-2 & VSDD20-2)	GASK20-2	077743
Gasket for VSGG20-2 & VSDD20-2 Double Gangs	GASKV20-2	072227

Weatherproof Covers - Double Gang - NEW Style
(only fits new style gang boxes)

Description	Part Number	Product Code
Toggle Switch Cover	VSCU20-2	077376
Combination Switch Cover & GFI Receptacle	VSRCU20-2	077357
Combination Switch Cover & Duplex Receptacle	VSDRU20-2	077356
Gasket	GASKFU20-2	172650

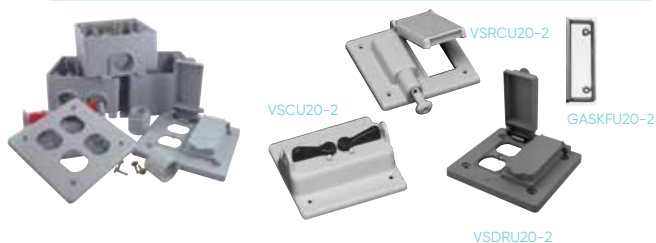

F Series Single Gang Boxes

Outside Dimensions:

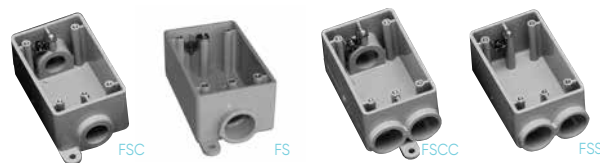
Height, $4\frac{9}{16}$ " - Width, $2\frac{13}{16}$ " - Depth 2", Cubic Inches = 25.67

Size (in)	Part Number	Product Code
1/2	FSC10	077607
3/4	FSC15	077608
1/2	FS10	077601
3/4	FS15	077602
1/2	FSCC10	077622
3/4	FSCC15	077623
1/2	FSS10	077604
3/4	FSS15	077605

Note: 10 = 1/2" Hub, 15 = 3/4" Hub

FD Series Single Gang Deep Boxes

Outside Dimensions:

Height, $4\frac{9}{16}$ " - Width, $2\frac{13}{16}$ " - Depth $2\frac{3}{4}$ ", Cubic Inches = 35.30

With the exception of the FD Blank Box, Scepter FD Series Single Gang Deep Boxes are molded with 1" conduit hubs and supplied with reducer bushings. The conduit hub(s) are field modified as 1/2", 3/4" or 1" to accommodate job-site requirements. The appropriate quantity of 1" x 3/4" and 3/4" x 1/2" reducers to create the desired hub size are packaged with each FD Series Single Gang Deep Box.

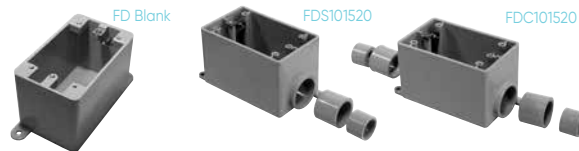

Size (in)	Part Number	Product Code
1/2, 3/4, 1	FDC101520	077291
1/2, 3/4, 1	FDS101520	077299
BLANK	FD BLANK	077603
347 VOLT	FD347	077610

F-Series Universal Double Gang Boxes – NEW Style

FSU-2 cu.in = 39.5, FSCU-2 & FSSU-2 cu.in. = 37.0, FSCCU-2 cu.in.= 36.0

Hub Size (in)	Part Number	Product Code	OD (inches)		
			H	W	D
1/2, 3/4, 1	FSU-2-101520	077364	4.5	4.75	2.5
1/2, 3/4, 1	FSCU-2-101520	077368	4.5	4.75	2.5
1/2, 3/4, 1	FSSU-2-101520	077372	4.5	4.75	2.5
1/2, 3/4, 1	FSCCU-2-101520	077369	4.5	4.75	2.5
Blank	FDU-2	077649	4.75	4.75	3.0

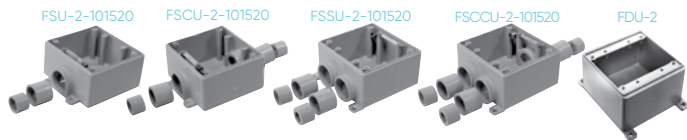

F Series Triple Gang Boxes

Hub Size (in)	Part Number	Product Code	OD (inches)		
			H	W	D
1/2, 3/4, 1	FS-3-101520	077337	4.5	6.6	2.5
1/2, 3/4, 1	FSC-3-101520	077438	4.5	6.6	2.5
Blank	FD-3	077737	4.5	6.6	3.0

Note: All F series boxes are supplied with integral mounting feet, threaded brass inserts and grounding clips.



Octagonal Boxes*

Octagonal Boxes are shipped complete with cover, gasket, 4 reducing bushings (3/4" x 1/2") and 3 knock-out plugs to be installed from inside box to seal off unused entry hubs.

Size (in)	Part Number	Hub Size (in)	Product Code
4 x 1-1/2	OB15/10	1/2 – 3/4	077983
4 x 2-1/8	OB20	1	077984

Octagonal Box Extension Rings

Size (in)	Part Number	Product Code
4 x 1 deep	XR20	077989*
4 x 2 deep	XR35	077990*



Octagonal Boxes are not designed for supporting luminaires.

Nonmetallic Floor Box, Cover & Metal Cover Adapter

Installation is quick and simple with our nonmetallic floor box and covers, saving both time and money over similar metallic assemblies.

Scepter's floor box and duplex receptacle covers are constructed from high impact, noncorroding and nonconducting PVC.

The flush-mount covers are available in custom colours and are shipped with a leveling ring complete with a grounding clip. Metal cover adapter kits are also available, allowing you to adapt to metal floor plates. Our 6" deep floor box allows flexibility for various concrete floor pours, while the 4 3/4" width offers easy access and ample wire room. Scepter's FB box is molded with 2 - 1" and 2 - 3/4" hub openings.

All boxes are shipped complete with reducer plugs for added versatility.

One Kit, Four Heights, One Low Cost!

This simple yet innovative Round Floor Box Stand is equipped with several height brackets which accommodate the different rebar and post-tension cable heights and slab depths found from jobsite to job-site. When installed together, the Floor Box and Stand can be used in 5-1/2" to 10" slab depths.



Sold as a Kit, IPEX offers the Round Floor Box and Stand conveniently packaged together as one complete product offering.

FEATURE & BENEFITS

- Four Adjustable Heights
- Withstands Tough Job Site Conditions
- Raises Entrance Hubs to Rebar
- Easy to Install
- Minimizes Footprint on Concrete Form
- Cost Effective

For more information, visit our website www.ipexna.com

Description	Part Number	Product Code
-------------	-------------	--------------

Floor Box Base

(Includes disposable protective cap & reducer plugs)

076954 FB



FB

Floor Box Base c/w Leveling Ring Adapter

(includes disposable protective cap, reducer plugs & leveling ring adapter)

077068 FBKIT



FBS-KIT

Floor Box Stand Kit (includes FB Box)

(is equipped with several height brackets which accommodate the different rebar and post-tension cable heights and slab depths found from job-site to job-site.)

077700 FBS-KIT



AFMC

Metal Cover Adapter Kit

(includes leveling ring, metal cover adapter and 2 gaskets)

076953 AFMC



LRA-U

Universal Leveling Ring Adapter

076606 LRA-U

Floor Box Duplex Receptacle Cover (Nonmetallic)

(includes flush mount cover, blank cover and gasket)

Brown	076943	FBDRCB
Gold	076942	FBDRCG
Grey	076941	FBDRCGr
Light Almond	076940	FBDRCA



FBUDK

Tri-Service Universal Divider Kit

(includes upper and lower dividers, riser tube and 2 grommets)

077948 FBUDK



FBUDK

Y Connector (3/4")

077499 FBYC



FBYC

Brass and Nickel Cover Plates

These cover plates help to protect enclosed power data and communications wiring from daily environmental floor conditions such as mopping (UL scrub water tested) and foot traffic (UL approved for cover loading).

The covers feature a light lacquer finish for extra strength and durability in high traffic areas and include a rubber gasket and aluminum backing plate to create a water-tight seal. The flush mount cover plates should be installed to the floor box using the LRA-U.



Nickel Cover Plates

Description	Part Number	Product Code
Duplex Receptacle Cover with Dual Flip Lid	DFL-2-N	178279
Duplex Receptacle Cover w/ Individual Screw Plug Openings	SSC-N	178278
Combination 2" x 1/2" Single Screw Plug Opening	DSC-N	178280



DFL-2-N



SSC-N



DSC-N

Brass Cover Plates

Description	Part Number	Product Code
Duplex Receptacle Cover with Dual Flip Lid	DFL-2	178096
Duplex Receptacle Cover w/ Individual Screw Plug Openings	SSC	178093
Combination 2" x 1/2" Single Screw Plug Opening	DSC	178091
Combination 2" x 1/2" Single Screw Plug and 1/2" Datacomm Opening	DSC-P/C	178092



DFL-2



SSC



DSC-N

Flanged Box with Fibre-Reinforced Safety Tread Cover

Scepter's JB Flanged 'H' Series Junction Boxes feature a fiber-reinforced safety tread cover which uses a recessed Hex Key fastening hardware for a simple installation while reducing the opportunity for tampering. These boxes are not CSA Certified and are not returnable.

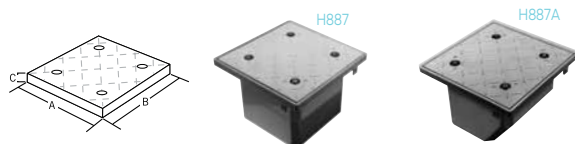

Part Number	Product Code	Box ID (in)			Lid Dimensions (in)		
		L	W	D	A	B	C
H664	077685	6	6	4-1/4	9.0	9.0	0.60
H666	077686	6	6	6-1/4	9.0	9.0	0.60
H884	077687	8	8	4-1/4	11.5	11.5	0.75
H886	077688	8	8	6-1/4	11.5	11.5	0.75
H887	077689	8	8	7-1/4	11.5	11.5	0.75
H887-A	077692	8	8	7-1/4	11.5	11.5	0.75

Fabricated Boxes

Unflanged PVC fabricated boxes of any size may be made to customers' specifications and come complete with lids, gaskets and screws. These boxes are not CSA Certified and are not returnable.

Junction Box Adapters

Size (in)	Part Number	Product Code	ID (in)	OD (inches)	L	OL
1/2	JBA10	077721	0.62	1.20	0.81	0.95
3/4	JBA15	077722	0.79	1.40	0.87	1.01
1	JBA20	077723	1.00	1.58	0.89	1.06
1-1/4	JBA25	077724	1.35	1.98	1.12	1.30
1-1/2	JBA30	077725	1.59	2.37	1.10	1.33
2	JBA35	077726	2.05	2.85	1.25	1.54
2-1/2	JBA40	077727	2.45	3.34	1.68	1.99
3	JBA45	077728	3.05	3.10	1.77	2.11
3-1/2	JBA50	077729	3.54	4.50	2.09	2.41
4	JBA55	077730	4.02	5.03	1.99	2.30

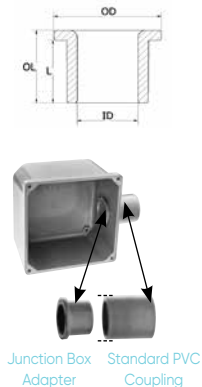

Junction Box Adapter Standard PVC Coupling

Conduit Cements

IPEX Electrical 100 Conduit Cements are low VOC. Our reduced emission cements have been tested to meet the requirements of SCAQMD Rule 1168, Test Method 316A (South Coast Air Quality Management District).

- Low VOC Solvent Cement is LEED (Leadership in Energy and Environmental Design) compliant.
- PVC is recyclable and can be reground into new product.
- VOC emissions are less than 510 grams per litre for PVC Solvent Cement.

IPEX 100 PVC Conduit Solvent Cement

	Size	Part Number	Product Code
	125ml	S100PT25	074717
	250ml	S100PT5	074713
	500ml	S100PT	074714
	1L	S100QT	074715
	4L	S100GAL	074716

IPEX 100T Primer

	Size	Part Number	Product Code
	250ml	C100PT5	074306
	500ml	C100PT	074307
	1L	C100QT	074308

Empty Applican

Size	Part Number	Product Code
500ml (Pint)	APPLICAN	074728

Average # of Joints per Pint or Quart of Cement

Nominal Pipe Size	# of Joints /Pint	# of Joints /Quart	Nominal Pipe Size		# of Joints /Pint	# of Joints /Quart
			inches	mm		
1/2	350	700	2-1/2	12	40	80
3/4	200	400	3	19	35	70
1	150	300	3-1/2	25	30	60
1-1/4	110	220	4	32	24	48
1-1/2	80	160	5	38	10	20
2	45	90	6	50	8	16

The RIGHT BOX for the RIGHT Environment



Scepter JBox has expanded its offering to include 14" and 16" molded PVC junction boxes...the LARGEST available anywhere!

FEATURES & BENEFITS

- NEMA 1,2,3R,4,4X,12,13
- 100% Nonmetallic
- Hand-close fastener tabs
- Back panels available for sizes 6" and up

Visit www.ipexna.com



SCEPTER JBOX: The Next Generation Junction Box

Introducing the Scepter® JBox™, the Next Generation Junction Box. The original junction box is completely redesigned and features have been added to make this the easiest box to use. The patent pending integral gasket, non-metallic fasteners, molded mounting feet, embossed grid-lines and flat cover features have been engineered to provide a contractor-friendly junction box.

NEMA Rated: 1,2,3R,4,4X,6*,6P*,12,13.

*Applies only to 4" to 12" non-hinged covers



Features and Benefits

Hand-Close Fasteners

- Close by hand – tool assist to open
- 100% non-metallic – corrosion resistant material
- No loose hardware for easy installation

Smooth Flat Cover

- No ribs – offers a flat, smooth surface for mounting of devices or labels

Integrated Gasket

- Injection molded and extruded gaskets permanently fixed to the cover – no installation required
- Proprietary gasket material creates a 6P rated enclosure (4" – 12")
- Neoprene gasket material creates a 4X rated enclosure (14" – 16")

Molded Mounting Feet

- Molded – no loose parts to assemble
- Located on corners out of the way of conduit connections
- Flush with the back of the box for close surface mounting
- Integrated design of mounting feet offers improved strength

Built-in Gridlines

- Easy reference for drilling knockouts
- Makes conduit alignment a snap



Size inches	Part Number	Product Code	L1	W1	L2	W2	H	M1 inches	M2	G1	G2	J1	J2	D	K
4x4x2	JBX442	277000	4.97	3.93	3.48	3.48	2.90	4.48	3.44	2.41	1.09	1.72	1.09	0.51	0.24
4x4x4	JBX444	277001	4.90	3.86	3.48	3.48	4.89	4.41	3.37	2.22	2.97	1.59	2.97	0.59	0.24
5x5x2	JBX552	277002	5.97	4.93	4.55	4.55	2.90	5.48	4.44	3.41	1.09	2.69	1.09	0.51	0.24
6x3x4	JBX634	277003	3.90	5.86	2.48	5.48	4.89	3.41	5.37	1.22	2.72	3.42	2.72	0.59	0.28
6x6x4	JBX664	277004	7.58	7.58	5.86	7.20	4.90	6.90	6.90	4.47	2.47	4.47	2.47	0.59	0.28
6x6x6	JBX666	277005	7.51	7.51	5.79	7.13	6.90	6.83	6.83	4.22	4.47	4.22	4.47	0.72	0.28

Size inches	Part Number	Product Code	L1	W1	L2	W2	H	M1 inches	M2	G1	G2	N1	N2	P1	P2	D	K
8x8x4	JBX884	277006	9.58	9.58	7.86	9.20	4.90	8.90	8.90	6.47	1.97	8.25	6.26	3.94	3.13	0.59	0.28
8x8x7	JBX887	277007	9.47	9.47	7.76	9.10	7.90	8.80	8.80	6.22	4.65	8.25	6.26	3.94	3.13	0.75	0.28
12x12x4	JBX12124	277008	13.58	12.24	11.74	11.74	4.90	12.90	11.56	9.28	2.03	10.26	10.25	3.94	3.13	0.56	0.28
12x12x6	JBX12126	277009	13.51	12.17	11.74	11.74	6.90	12.83	11.49	9.03	3.78	10.26	10.25	3.94	3.13	0.67	0.28
12x12x8	JBX12128	277010	13.44	12.10	11.74	11.74	8.90	12.76	11.42	8.81	5.64	10.26	10.25	3.94	3.13	0.76	0.28
14x14x8	JBX14148	277011	15.72	14.39	13.80	13.80	9.1	15.10	13.70	11.05	5.69	12.25	10.26	3.94	3.16	0.83	0.33
14x14x10	JBX141410	277012	15.66	14.32	13.80	13.80	11.1	14.98	13.64	11.05	7.55	12.25	10.26	3.94	3.16	0.83	0.33
16x16x10	JBX161610	277013	17.64	16.30	15.71	15.71	11.1	17.00	15.60	12.55	7.55	14.25	12.26	4.71	4.09	0.83	0.33

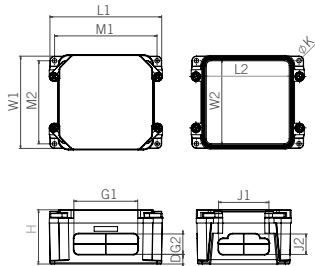

JBX442 - JBX666

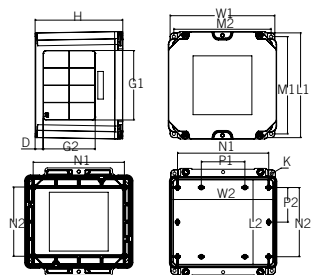

JBX884 - JBX887

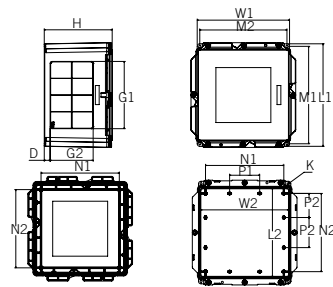

JBX12124 - JBX161610

Scepter JBox with Hinged Cover

The Hinged Cover opens up to 214° and are removable for complete and easy access to control devices and instrumentation. The Scepter JBox Hinged Cover is NEMA 3R and 4X rated, ideally suited for indoor and outdoor industrial, MRO and OEM applications, and in wash-down environments. It is 100% nonmetallic and includes all the features that users have come to appreciate in the Scepter JBox.



NEMA Rated: 1,2,3R,4,4X,12,13

Size inches	Part Number	Product Code	L1	W1	L2	W2	H	M1	M2	G1	G2	N1	N2	P1	P2	D	K
8x8x4	JBXH884	277100	9.58	9.58	7.86	9.2	4.9	8.9	8.9	6.47	1.97	8.25	6.26	3.94	3.13	0.59	0.28
8x8x7	JBXH887	277101	9.47	9.47	7.86	9.2	7.9	8.9	8.9	6.22	4.65	8.25	6.26	3.94	3.13	0.75	0.28
12x10x6	JBXH12106	277102	11.51	12.17	9.67	11.67	6.9	10.8	11.49	8.03	3.78	10.25	8.26	3.94	2.16	0.67	0.28
12x12x4	JBXH12124	277103	13.58	12.24	11.74	11.74	4.9	12.9	11.56	9.28	2.03	10.26	10.25	3.94	3.13	0.56	0.28
12x12x6	JBXH12126	277104	13.51	12.17	11.74	11.74	6.9	12.83	11.49	9.03	3.78	10.26	10.25	3.94	3.13	0.67	0.28
12x12x8	JBXH12128	277105	13.44	12.10	11.74	11.74	8.9	12.76	11.42	8.81	5.64	10.26	10.25	3.94	3.13	0.76	0.28
14x14x8	JBXH14148	277106	15.72	14.39	13.80	13.80	9.1	15.10	13.70	11.05	5.69	12.25	10.26	3.94	3.16	0.83	0.33
14x14x10	JBXH141410	277107	15.66	14.32	13.80	13.80	11.1	14.98	13.64	11.05	7.55	12.25	10.26	3.94	3.16	0.83	0.33
16x16x10	JBXH161610	277108	17.64	16.30	15.71	15.71	11.1	17.0	15.60	12.55	7.55	14.25	12.26	4.71	4.09	0.83	0.33

Scepter JBox Pole Mounting Kit

- Available in either galvanized or stainless steel (SS)
- Supplied as complete kits (sold separately)
- Works with wood, concrete, steel and composite poles
- Installs on round, square & octagonal poles up to 15"



Part Number	Product Code	Fits JBox
PMK4-12	077940	4" to 12"
PMK4-12SS	077946	4" to 12"
PMK14-16SS	277086	14" to 16"

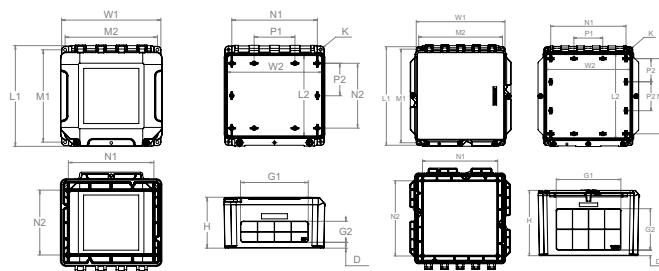

JBXH884 - JBXH887

JBXH12106 - JBXH161610

Scepter JBox Back Panels

- Made of 14 gauge carbon steel
- White epoxy powder-coated finish
- Easy to cut and drill to mount devices

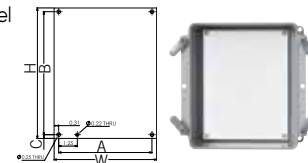

Size inches	Part Number	Product Code	W	H	A	B	C
6x6	BP66CSW	077864	4.88	6.75	4.26	6.25	0.25
8x8	BP88CSW	077861	6.88	8.75	6.26	8.25	0.25
12x10	BP1210CSW	077862	8.88	10.75	8.26	10.25	0.25
12x12	BP1212CSW	077865	10.88	10.75	10.26	10.25	0.25
14x14	BP1414CSW	077867	10.88	12.75	10.26	12.25	0.25
16x16	BP1616CSW	077868	12.88	14.75	12.26	14.25	0.25

Conduit Repair Kit

EPR Kit for Conduit Repair

EPR Kits from IPEX are the first total repair systems for broken and damaged PVC conduit. They offer fast and easy repairs for damaged conduit caused by actions such as earth excavation, horizontal and core drilling.

All sizes are 24 inches in length.



Size (in)	Part Number	Product Code
1-1/4	EPR25	077982
1-1/2	EPR30	077981
2	EPR35	077980
2-1/2	EPR40	077960
3	EPR45	077958
4	EPR55	077957
5	EPR60	077956
6	EPR65	077955

EPR Kit Adapters for Duct Repair

EPR Conduit Repair Kits allow contractors to repair a broken section of DB-II duct while leaving the cables inside. The Adapters are pre-cut allowing each to open around existing cabling and are then solvent cemented onto the outside diameter of the broken duct. Using standard PVC solvent cement, an EPR Kit is then easily assembled and connected to the Adapters, restoring the duct to its original form.



Size (in)	Part Number	Product Code
2	EPRA35	077852
3	EPRA45	077853
4	EPRA55	077854
5	EPRA60	077855
6	EPRA65	077856



SCEPTALIGHT: The Light That Lasts

Whether you're looking for economical outdoor lighting solutions, corrosion-resistant fixtures for punishing industrial environments or energy-saving LED, Sceptalight fixtures from IPEX prove themselves to be all-round performers in a variety of indoor and outdoor applications. Sceptalight fixtures are made from a glass-reinforced thermoplastic polyester resin, which enable them to stand up better to corrosive elements than metal. This thermoplastic design marries an unrivaled balance of strength, stiffness and toughness with all the benefits users appreciate of Scepter Rigid PVC Conduit and Fittings – long life, easy servicing and high impact-resistance.

Sceptalight's thermoplastic construction offers outstanding corrosion and chemical resistance. Silicone gaskets in Sceptalight fixtures – mounted at the base of the globe and within the ceiling box – provide a water- and vapour-tight seal which protects the electrical connections inside.

Wherever you need a lighting fixture that can withstand exposure to chemicals, fluids or harsh physical conditions, you'll find a home for Sceptalight.

Features and Benefits

Available in LED, compact fluorescent and incandescent to suit a variety of applications

- Stable Construction
- Adaptable
- Watertight Seal
- Long Life
- Indoor/Outdoor Use
- Corrosion Resistant
- Durable, Impact Resistant



Wet Locations

C22.2 No. 250
CSA Listed to UL 1598
Minimum 60°C supply conductors

CSA certified for wet locations, Sceptalight fixtures are built to withstand any environment where liquids drip, splash or flow against electrical equipment. And our polycarbonate globes are an excellent alternative to glass in punishing environments where high impact resistance is important. Sceptalight fixtures can operate in extreme temperatures and are resistant to damaging ultraviolet rays. For years, our fixtures have been proven performers on docks, wharves, decks, walkways, shipyards and a variety of other applications where exposed to the elements.

LIGHT OPTIONS

LED	✓
Incandescent	✓
Compact Fluorescent	✓



Hazardous Locations

CSA Listed to UL 844
CLASS I, DIV 2 Groups A, B, C & D
CLASS II, DIV 2 Groups F & G
Minimum 90°C supply conductors

Sceptalight offers fixtures that are CSA certified for hazardous locations, making them the ideal choice for specific harsh industrial environments involving flammable or explosive gases, vapours or dust. In addition to their sturdy construction, all our fixtures rated for hazardous locations include a heat-treated globe designed to endure drastic temperature changes such as direct spray of cool water on a hot fixture. Sceptalight fixtures are equipped with brass screws and inserts to ensure performance in punishing industrial conditions.

LIGHT OPTIONS

LED	✓
-----	---

Sceptalight LED



Introducing three Sceptalight LED products: the LED Retrofit Light Engine, the Heavy-Duty LED Light Fixture and the Utility LED Light Fixture. Sceptalight LEDs offer significant energy savings, up to 85% compared to incandescent, and up to 34% compared to fluorescents. Moreover, Sceptalight LEDs can last beyond 50,000 hours without a single need for maintenance.

Constructed of very strong and durable materials, the polycarbonate globe is impact resistant and is resistant to UV light degradation. The specially designed aluminum heat sink dissipates the heat generated by the LEDs to the exterior environment ensuring long-life and optimal performance in both hot and cold environments. Sceptalight LEDs have been tested and certified for use in indoor, outdoor, wet location, wash down, and corrosive and hazardous* environments. They are certified to the latest LED light fixture standards and NEMA 4X approved.

* LVPF-LED-HAZ only

Retrofit Option

Sceptalight LEDs can easily retrofit onto existing installations for increased energy savings

Dimmable

Lights are dimmable down to 5% for maximum control of the lighting environment

Corrosion Resistant

Heat sink is coated with a durable e-coat layer that prevents corrosion

NEMA 4X and IP66 Rated

Approved for wet locations, wash down and corrosive environments

Heat Dissipation

Specially designed heat sink ensures long life and optimum performance for over 50,000 hours

Energy Efficient

1,575 lumens of light output is produced with only 15 Watts of electricity

Polycarbonate Globe

Impact and weather resistant for tough environments

Sceptalight COMPACT FLUORESCENT



Sceptalight Compact Fluorescent fixtures combine the outstanding corrosion and chemical resistance of their thermoplastic design with the energy-saving advantages of compact fluorescents. Working four to five times more efficiently per watt than incandescents, Sceptalight compact fluorescents provide 10-20 times the lamp life. Without sacrificing light levels, they use 75% less energy than incandescents for a lower total energy and maintenance cost. They are available in twin tube and quad tube configurations and include ballast.

Quad Tubes

- Available in 18 & 26 Watt
- Electronic Ballast provides "Instant Start" at temps as low as -25°C
- Offers 10,000 hours of lamp life

Stable Construction

Reinforced support feet offer secure mounting

Adaptable

Threaded conduit hubs permit connection to nonmetallic and metallic raceways

Watertight Seal

Threaded conduit hubs permit connection to nonmetallic and metallic raceways

Long Life

Sceptalight nonmetallic fixtures provide long life and easy servicing—unlike metal fixtures and guards that can corrode and seize together

Indoor/Outdoor Use

Sceptalight nonmetallic fixtures provide long life and easy servicing—unlike metal fixtures and guards that can corrode and seize together

Corrosion Resistant

Thermoplastic construction resists attack from acids, alcohols, alkalis, organic solvents, detergents/cleaners, greases and oils as well as many other types of chemicals. Withstands exposure to direct sunlight, heat, and extreme weather

Durable, Impact Resistance

High-impact nonmetallic guard resists physical impact, chemical attack and heat-induced deformation

Sceptalight INCANDESCENT



Sceptalight incandescent fixtures make the most practical choice to meet the daily needs of commercial, industrial, marine and agricultural applications. Our incandescents will take up to a 150 watt incandescent bulb and are ideal for short burn times as well as flashing and dimming applications.

For light to medium duty applications that do not require the same level of ruggedness, Sceptalight has a low-cost ceiling-mounted Utility Light Fixture available in standard, clear polycarbonate and coloured heat-resistant globes.

Installation Flexibility

Fixtures can be mounted in ceiling, wall or pendant methods to accommodate installation requirements

Indoor/Outdoor Use

Temperature and weather-resistant gaskets protect fixture from moisture penetration

Cost Effective Solution

Inexpensive to install, the fixture takes up to a 150 watt incandescent bulb

Adaptable Lighting Environments

Ideal for short burn times, flashing & dimming applications

Coloured Globes Available

Available in a range of coloured heat-resistant globes to transform the light into an indicator or warning light

Corrosion Resistant

Thermoplastic construction withstands exposure to direct sunlight, heat & extreme weather



Wet Location Use

Ceiling Mount w/ Frosted Polycarbonate Globe		Part Number	Product Code	Hub Sizes
15W	LED Retrofit Light Engine	LLED-15	277120	-
15W	LVPF Heavy Duty Light Fixture	LVPF-LED-HAZ	277121	4 x 3 /4"
15W	LVPE Utility Light Fixture	LVPE-LED	277122	2 x 1/2" to 2 x 3/4"

Ceiling Mount w/ Standard Clear Glass Globe		Part Number	Product Code	Hub Sizes
26W	Compact Fluorescent	LVPL26C	077170	4 x 3/4"
18W	Compact Fluorescent	LVPL18C	077210	4 x 3/4"

Ceiling Mount w/ Clear Polycarbonate Glass Globe (no guard)		Part Number	Product Code	Hub Sizes
26W	Compact Fluorescent	LVPL26PCC	077176	4 x 3/4"
18W	Compact Fluorescent	LVPL18PCC	077211	4 x 3/4"

Wall Mount Bracket (for WET Locations)		Part Number	Product Code
For wall mount fixtures select and order the appropriate style (wattage and globe) ceiling mount fixture from above and add LWB150 Wall Mount bracket		LWB150	077233

Ceiling Utility Light Fixture 150 Watt Incandescent		Part Number	Product Code
w/ Clear Glass Globe		LVPE150-10/15	077493
w/ Polycarbonate Globe		LVPE150-PCC*	077181
w/ Standard glass globe & guard Maximum 60W incandescent lamp with polycarbonate globe		LVPE150-1015G	077402
w/ Heat-resistant glass globe RED		LVPE150-HRR	077599
w/ Heat-resistant glass globe BLUE		LVPE150-HRB	077579
Clamp-on guard for LVPE		LVPU150	077558

Hub Sizes for these Light Fixtures are 2 x 1/2" to 2 x 3/4"



Hazardous Locations

Ceiling Mount w/ Frosted Polycarbonate Globe		Part Number	Product Code	Hub Sizes
15W	LVPF Heavy Duty Light Fixture	LVPF-LED-HAZ	277121	4 x 3/4"

All hazardous location fixtures are rated CLASS I, DIV 2 Groups A, B, C & D and CLASS II DIV 2 Groups F & G.

Accessories & Components

Standard Glass Globes

Description	Part Number	Product Code
Clear	LGC150	077247

Heat Resistant Globes

Description	Part Number	Product Code
Clear	LG150T	077909
Red	LCGR150T	077239
Blue	LCGB150T	077910

Polycarbonate Globes (for use with compact fluorescent or maximum 60W incandescent lamp)

Description	Part Number	Product Code
Clear	LPCC18	072833
Red	LPCR18	077912

Threaded Junction Boxes

Description	Part Number	Product Code
	LFB150C	077250
	LFB150T *	077251

*LFB150T complete with 1/2 threaded" hole in center of cover

Fixture Components (LVPF, LVPL, LPMF, LPPL)

Description	Part Number	Product Code
Ceiling Mount Box	LVPB 150	077243
Pendant Mount Cap	LPC 150	077246
90 Wall Bracket	LWB 150	077233

Replacement Lamp Holders

Description	Part Number	Product Code
18 Watt Lamp Holder (4 Pin)	LLH 18	072818

Ballasts

Description	Part Number	Product Code
26 Watt Electronic Ballast (HPF)	LEB 26	077080

Gaskets

Description	Part Number	Product Code
Box Gasket	LBGASK 150	072820

Mounting Options

Sceptalight LED can be retrofit with Ceiling Mounts only.

Ceiling Mount Box with threaded hubs and integral mounting feet

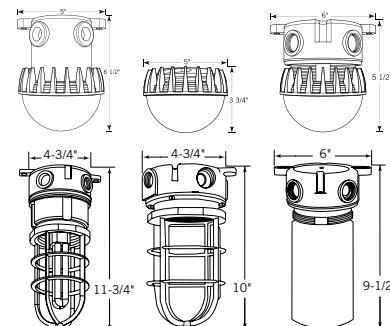

Ceiling Mount Utility Fixtures
Box with threaded hubs and integral mounting feet

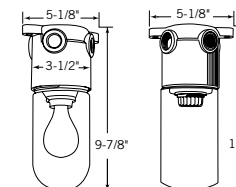

Globe Options

(For incandescent and fluorescent options only)

Standard Clear Glass Globes

Ideal for general purpose area lighting for either indoor or outdoor use.



Clear Polycarbonate Globes

Impact resistant globes for added protection in case of accidental contact

Coloured Heat-Resistant Glass Globes

Available in red or blue – to transform the light to an indicator or warning light.





We've Got You Covered

IPEX Electrical made in-slab electrical raceways faster to install by introducing the industry's first true, integrated ENT system – long lengths of flexible tubing reduce the number of couplings needed. Cor-Line tubing and Kwikon fittings work together to provide the most robust concrete tight ENT system on the market.



Cor-Line® ENT

- Concrete-tight, requiring no solvent welding or tape around connections
- Flexible enough to be bent by hand and tough enough to withstand crushing and breaking
- Made of impact resistant PVC, so it won't break or crack

Kwikon® Slab Boxes

- Approved for support of ceiling fans up to 35 lbs and luminaries up to 50 lbs
- All molded connectors have 360° locking tabs that exceed UL and CSA requirements for pull-out
- Threaded brass inserts (10/32 for ceiling fans, 8/32 for luminaries)



Cor-Line ENT – Savings for the Long Run

Noncorroding and nonconducting, Cor-Line Electrical Nonmetallic Tubing and fittings are designed *For The Long Run*. Coiled in lengths up to 1,500 feet, the Cor-Line system can span the longest run. Encased in concrete, concealed in walls or ceilings, Cor-Line offers the best alternative to the labour-intensive, 10' lengths of metal conduit with its couplings and scrap. The Cor-Line System is the right choice!

Kwikon Fittings

Our unique Kwikon couplings, transition couplings and connectors are designed with six 360° locking tabs to ensure a secure concrete-tight connection. Should water-tight connections or transitions to Rigid PVC Conduit be required, Corline ENT may be joined to Rigid PVC Fittings using solvent cement. Normal application of solvent cement may be used inside the Rigid PVC socket while it is recommended to apply cement sparingly on the Corline ENT pipe end before assembly.

Time-consuming taping and solvent cementing are eliminated.



C222 – No. 227.1

Ease of Installation

Engineered for the rugged day-to-day challenges of the construction industry, Cor-Line has already established itself as a market leader. Requiring no special tools for bending or cutting, Cor-Line is easily installed.



Bending & Cutting

Cor-Line's corrugated construction allows it to be easily bent by hand, no longer requiring special bending equipment traditionally required with metal conduit systems. When bending, ensure the radius of the curve is at least six times the internal diameter of the tubing.



Pre-Assembly of Kwikon Slab Boxes

IPEX's Kwikon slab boxes are available with or without molded connectors. For boxes without molded connectors, pre-assembly is quick and simple using our snap-in connector or threaded male adapter with locknuts. Both provide a secure concrete-tight connection.



Pre-Assembly of Metallic Boxes

Metallic slab boxes can be quickly pre-assembled with Kwikon connectors. Secured with a locknut, Kwikon connectors provide a concrete-tight connection.



Installation in Sheer Walls, Interior Walls & Block Walls

Cor-Line's flexibility, lightweight and ease of handling in metal, wood, or block walls, combined with Kwikon connectors and couplings, substantially reduce time and labour needed to install electrical raceways.



Pulling Wire

Kwikon's interior corrugated surface greatly reduces the amount of friction while pulling conductors through long runs, even with 90° bends.



CSA Certified

Cor-Line Electrical nonmetallic tubing and Kwikon fittings are certified to CSA C22.2 No. 227.1.

FT-4 Approved

IPEX Cor-Line ENT tubing meets and exceeds the requirements of CSA's vertical char test as described in Clause 4.11.4 of CSA C22.2 No. 0.3M.



Direct Burial

The Canadian Electrical Code approves ENT for direct earth burial. Rules governing installation of Cor-Line ENT are covered in the CEC Part 1, Rule 12-1500 through 12-1516.

Installation in Noncombustible/Combustible Construction

Refer to Section 3.1.5.19 of the National Building Code for rules governing the use of combustible conduit in noncombustible and/or combustible buildings. Where provincial codes vary, please consult with the building authority having jurisdiction.



Storage and Handling

- NOT to be installed, stored, or handled in cold temperatures below -20°C (-4°F).
- NOT to be stored outside

Nonmetallic Raceways for Fire Alarm System Conductors

Rule 32-102 of the CE Code allows Cor-Line ENT to be used for fire alarm systems in noncombustible or combustible buildings provided: (1) the raceway is embedded in at least 50mm (2 in.) of masonry or poured concrete, and (2) where electrical nonmetallic tubing (ENT) is used, the transition from ENT to metal raceways is made in the concrete using a transition fitting or other acceptable means. (Kwikon transition fittings are specifically designed for this application.)



Cor-Line Dimensions

Nominal Size		Average O.D.		Average I. D.	
inches	mm	inches	mm	inches	mm
1/2	12	0.84	21.3	0.602	15.3
3/4	20	1.05	26.7	0.804	20.4
1	25	1.315	33.4	1.029	26.1
1-1/4	32	1.66	42.2	1.360	34.5
1-1/2	40	1.90	48.3	1.590	40.4
2	50	2.375	60.3	2.047	52.0
2-1/2	65	2.866	72.8	2.469	62.7

Weight Comparison of Cor-Line ENT vs EMT

Size (in)	ENT lbs/1000'	EMT lbs/1000'
1/2	100	295
3/4	125	440
1	175	668
1-1/4	185	970
1-1/2	220	1,100
2	319	1,517

Reel & Coil Size

	Size (in)	Length (ft)	Product Code	Wgt lbs/pkg	
Reel	1/2	1500	012004	185	
	3/4	1000	012009	145	
	1	750	012019	155	
	1-1/4	1000	012047	205	
	1-1/2	750	012033	180	
	2	500	012044	160	
Coil	2-1/2	325	012049	70	
	1/2	370	012000	37	
	3/4	240	012008	30	
	1	160	012018	28	
	1-1/4	500	012046	102	
	1-1/2	300	012032	72	
	2	225	012043	62	

Wrapped in plastic, coils are easily dispensed from the centre.

10' Sticks

Size (in)	Length (ft)	Product Code	Wgt lbs/pkg
1/2 x 10'	3600	012005	345
3/4 x 10'	2200	012006	315
1 x 10'	1800	012007	345

Kwikon Coupling

Size (in)	Part Number	Product Code	
1/2	KC10	089000	
3/4	KC15	089001	
1	KC20	089002	
1-1/4	KC25	189670	
1-1/2	KC30	189671	
2	KC35	189672	
2-1/2	KC40	089075	

Kwikon Connector For Concrete Encasement

Size (in)	Part Number	Product Code	
1/2	KTA10	089006	
3/4	KTA15	089007	
1	KTA20	089008	
1-1/4	KTA25	189680	
1-1/2	KTA30	189681	
2	KTA35	189682	
2-1/2	KTA40	089076	

Kwikon Snap-in Connector

Size (in)	Part Number	Product Code	
1/2	KTS10	089146	
3/4	KTS15	089147	
1	KTS20	089148	

Kwikon Transition Coupling

Size (in)	Part Number	Product Code	
1/2	KTC10	089012	
3/4	KTC15	089013	
1	KTC20	089014	

Kwikon ENT to AC90 Adapter

Size (in)	Part Number	Product Code
3/4 x 1/2	KFA 15/10	089079



Kwikon 90° Stub Down Fittings (Kwikon x Threaded)

Size (in)	Part Number	Product Code
1/2	KT90-10	089060
3/4	KT90-15	089059
1	KT90-20	089058



Kwikon 90° Stub Down Fittings (Kwikon x Kwikon)

Size (in)	Part Number	Product Code
1/2	KK90-10	089055
3/4	KK90-15	089056
1	KK90-20	089057



Kwikon ENT Form Stubby

Size (in)	Part Number	Product Code
1/2	KSTB-10	089330
3/4	KSTB-15	089331
1	KSTB-20	089332
1-1/4	KSTB-25	089333



Kwikon ENT Multi-Link™ Form Stubby

Size (in)	Part Number	Product Code
1/2	MSTB-10	089031
3/4	MSTB-15	089026
1	MSTB-20	089025



Kwikon ENT Angled Form Stubby

Size (in)	Part Number	Product Code
1/2	KASTB-10	089233
3/4	KASTB-15	089234
1	KASTB-20	089235
1-1/4	KASTB-25	089236
1-1/2	KASTB-30	089238
2	KASTB-35	089239
2-1/2	KASTB-40	089240



Kwikon Slab Box

Engineered to be rugged and durable, IPEX's boxes will withstand construction's harshest environments.

Designed by contractors for contractors, Kwikon slab boxes are available in two unique styles, with or without molded connectors. Now you can provide a complete, nonmetallic slab system. Priced competitively with traditional steel mud boxes, Kwikon slab boxes increase labour efficiencies, reducing costs.

Features

- Approved for use with ceiling fans up to 35 lbs. and luminaries up to 50 lbs.
- Concrete tight
- All molded connectors have 360° locking tabs that exceed CSA and UL requirements for pull-out
- Molded connectors are also approved for use with Scepter Rigid PVC Conduit
- Manufactured from high impact PVC
- Nonmetallic / Nonconducting / Noncorroding
- Threaded brass inserts
- Clear Cover vacuum formed removable covers

Slab Box w/ Molded Connectors – Vol 44 cu in.

Hub Size (in)	Part Number	Product Code
8 x 1/2	SMBH-10	089455
4 x 1/2, 2 x 3/4, 2 x 1	SMBH-10/15/20	089456
4 x 1/2, 4 x 3/4	SMBH-10/15	089457
8 x 3/4	SMBH-15	089459
4 x 3/4, 4 x 1	SMBH-15/20	089463



Slab Box w/o Molded Connectors – Vol 44 cu in.

Knockout Size (in)	Part Number	Product Code
8 x 1/2	SMB-10	089450
4 x 1/2, 2 x 3/4, 2 x 1	SMB-10/15/20	089451



Slab Box Extension Ring

Part Number	Product Code
SMBR	089494



Adjusts height of SMB/SMBH series slab boxes by 1"

4" Square Slab Box – Vol 44 cu in.

Hub Size (in)	Part Number	Product Code
8 x 1/2	SSBH-10	089452
8 x 3/4	SSBH-15	089453
4 x 1/2 & 4 x 3/4	SSBH-10/15	089454
4 x 3/4, 4 x 1	SSBH-15/20	089471

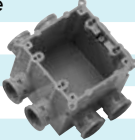

Shallow Slab Box – Vol 36 cu in.

Hub Size (in)	Part Number	Product Code
8 x 1/2	SMBSH-10	089485
4 x 1/2 & 4 x 3/4	SMBSH-10/15	089486
8 x 3/4"	SMBSH-15	089487
4 x 1/2, 2 x 3/4, 2 x 1	SMBSH-10/15/20	089488
4 x 3/4 & 4 x 1	SMBSH-15/20	089489



Concrete Wall Boxes

- Fully assembled and installation ready
- Perfectly suited for deep or shallow construction preferences
- Concrete-tight poly film covering the box opening
- Kwikon hubs do not protrude inside the box
- Clear Cover vacuum formed removable covers

3-1/2" Deep Concrete Wall Box – Vol 36 cu in.

Size (in)	Part Number	Product Code
4 x 1/2 & 4 x 3/4	SVDBH-10/15	089496
4 x 3/4 & 4 x 1	SVDBH-15/20	089049
4 x 1/2, 2 x 3/4, 2 x 1	SVDBH-10/15/20	089052
8 x 3/4"	SVDBH-15	089065



2" Shallow Concrete Wall Box – Vol 15 cu in.

Hub Size (in)	Part Number	Product Code
4 x 1/2	SVSBH-10	089054
4 x 3/4	SVSBH-15	089053



The **ENT Support Unit (ESU)** raises the tubing or conduit up off the concrete form during the concrete pour maintaining a level raceway and allows for maximum aggregate flow and concrete consolidation.



Easy to use, the ESU snaps around any size of ENT. It is perfect for use in high rise buildings constructed with post-tensioned (PT) concrete slabs.

Features

- One size fits all 1/2" - 2"
- Saves time and labour
- Easy locking mechanism
- Securable to the concrete form
- Minimal footprint reduces amount of surface contact

Part Number	Product Code
ESU-10-35	089149

Accessories

Tapered Plugs

Size (in)	Part Number	Product Code
1/2	TP10	089003
3/4	TP15	089004
1	TP20	089005



Kwikon Cutter & Blades

Description	Part Number	Product Code
Cutter (1/2" - 1")	CLC20	089066
Blades for CLC20	SSB	089067
Cutter (1/2" - 2")	CLC35	089068
Blades for CLC35	SB35	089069



INEXO™

THE ICF BOX

Full flange prevents box from twisting and sinking into foam if over-tightened

INEXO provides a 1/2" drywall setback resulting in a professional finish

Insertion depth of 2-1/4"

'TEETH' can be easily removed and replaced

'TEETH' lock in place providing a rigid hold in the EPS foam

Greater installation versatility with 3 screw hole choices and flanges on both sides

Single gang box provides 19 cubic inch capacity

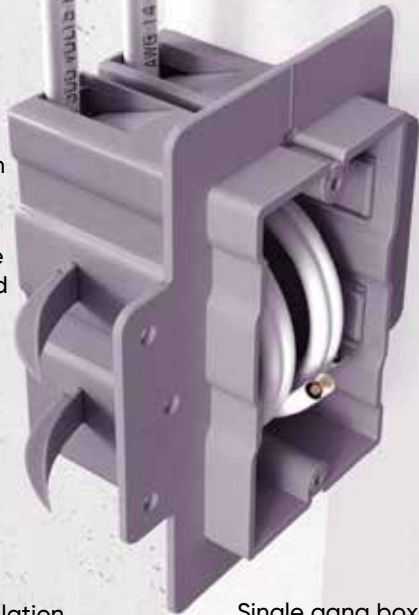

THE INNOVATIVE ELECTRICAL BOX FOR INSULATED CONCRETE FORM CONSTRUCTION

INEXO® Electrical Boxes - the only approved electrical box for ICF construction!

Available in commercial and residential styles.



INEXO Boxes for ICF Construction

Until now there have been few choices when attempting to provide a truly professional electrical box solution for Insulated Concrete Form homes.

INEXO's patented design provides a truly professional solution that works with your production schedule and provides the quality installation and finished look that builders require and owners appreciate. INEXO boxes link seamlessly with existing ICF materials, tools and methods. A complete offering designed for ICF walls allow builders to standardize on the use of electrical boxes throughout the building.

Residential (NMD Cable 14/2 – 10/3)

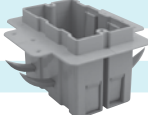
	Description	Part Number	Product Code
	Single Gang	ICF-1-RLX	220003
	Double Gang	ICF-2-RLX	220004
	Triple Gang	ICF-3-RLX	220005

Commercial (AC or NMD Cable)

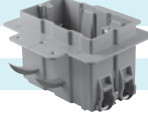
	Description	Part Number	Product Code
	Single Gang	ICF-1-CU	220006
	Double Gang	ICF-2-CU	220007
	Triple Gang	ICF-3-CU	220008

Low Voltage Divider

	Description	Part Number	Product Code
	Divider	LVD-RLX	220100
	For residential box only		

NOTES



Super Duct Pipe and Fittings

Super Duct is recognized by major utilities, contractors and engineering firms as the premier ducting product available on the market.

Super Duct is manufactured with a specialized compound and engineered for high impact and crush strength specifically required by utilities for underground duct. This compound enhances the friction coefficient of Super Duct for easier pulling of conductors/ wires through long runs.

Rigid Super Duct (Type DB-2) conforms to the testing requirements of CSA Standard C22.2 No. 211.1 both for encasement in concrete/ masonry and for direct burial.



CSA C22.2
No. 211.1

Lightweight

Super Duct is easy to carry and install, reducing labour and costs.

Long Lengths

Super Duct is available in 10' and 20' lengths, minimizing the number of connections needed.

Bell Ends

Super Duct is bell-ended, allowing for easy assembly in the field.

High Compressive Strength

Super Duct's specially formulated compound is designed to withstand high loads.

Low Coefficient of Friction

The smooth bore of Super Duct facilitates cable pulling and eliminates costly cable damage.

Quality Control

Stringent, continuous testing ensures that Super Duct is a consistently high quality product.



Super Duct (Type DB-2)

Description	CSA Requirements	Reference
Pipe Stiffness @ 5%	43.5 psi (300 kPa)	CSA C22.2 No. 211.1
Crush Resistance	198 lbs. @ 73°F (90 kg @ 23°C) 10% max. residual deflection	CSA C22.2 No. 211.1
Impact Resistance	45 ft. lbf @ 73°F (61J @ 23°C) 25 ft. lbf @ 0°F (34J @ -18°C)	CSA C22.2 No. 211.1
Residual Stress	149°F (65°C) for 4 hours. Allow to cool to 73°F (23°C). 0.5% shrinkage allowed.	CSA C22.2 No. 211.1
Joint Tightness	5 psi (35 kPa) internal water pressure applied for 24 hours.	CSA C22.2 No. 211.1

Note: Super Duct meets or exceeds all CSA requirements.

Field Bending

The natural flexibility of IPEX Super Duct allows field bending, so minor changes in elevation or direction can often be accommodated without the use of special sweeps or fittings. The following table indicates typical maximum offset bends that can be achieved by "cold bending."

Allowable Offset for Super Duct

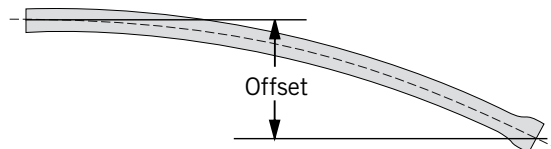

Size		Max Allowable Offset 10' Length		Max Allowable Offset 20' Length	
in.	mm	in.	mm	in.	mm
2	50	20	508	79	2 007
3	75	14	356	56	1 422
3-1/2	90	12	305	49	1 245
4	100	11	279	43	1 092
5	125	7	178	35	889
6	150	7	178	29	737

NOTES:

1. Axial deflection should not be attempted at the joints.
2. The above values were established for ambient temperatures above the freezing point. Increased radii may be desirable at below-freezing temperatures.

Bends

Standard 90°, 45° and 22 1/2° bends are available from sizes 2" through to 6" in 24", 36", 42" and 60" radius. All bends are supplied with 6" (15.2cm) tangents. The centre line lay length (L) can be calculated using;

$$L = \left(\pi r \times \frac{S}{180} \right) + 2 (\text{tangent})$$

Where: $\pi = 3.14$

L = centre line lay length

r = radius of bend

S = angle of bend

tangent = 6"

Example: for a 3" 90° bend with a 36" radius - calculate the lay length:

$$L = \left(3.14 \times 36 \times \frac{90^\circ}{180^\circ} \right) + 2 (6)$$

$$L = 69 \text{ inches}$$

$$L(\text{metres}) = \frac{L_{\text{imperial}}}{12 \times 3.281} = \frac{69}{39.37} = 1.75\text{m}$$

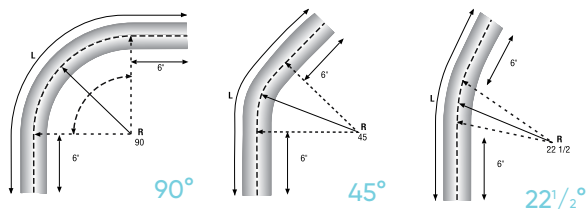

Static Friction Coefficient

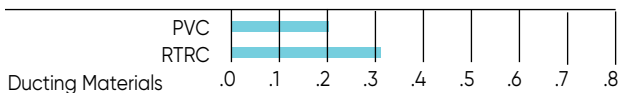

Concrete Encased Duct Installation

For multipurpose power cable and communication duct banks, spacing between ducts is critical for optimum performance. IPEX has designed the Monobloc and Vertical Lok Spacer systems to accommodate all specification and field installations.

These light weight spacers provide the vertical and horizontal separation required in a trench.

With spacers in place on the trench bottom, lay the first tier of ducts. When using a concrete base, lay the bottom tier before the base has taken initial set. Place subsequent tiers of spacers on top of the tier until the required number of ducts are installed. Then tie the entire assembly together. It is not necessary to weight or brace the bank unless the concrete mix is very wet.



The Concrete Pour

Do not allow a heavy mass of concrete to fall directly onto the duct. If this is a possibility, use a plank to direct the concrete down the sides of the bank assembly to the trench bottom. The concrete will flow to the centre of the bank and rise up in the middle, uniformly filling all open spaces. Voids can be eliminated by carefully working a long, flat slicing bar or spatula up and down between the vertical rows of ducts. Concrete should then flow between and under all of the ducts.

Duct Bank Elevation

Monobloc spacers should be staggered. It is recommended that spacers be located approximately one-fifth of duct length from each end. Vertical Lok spacers should be located to a maximum of every 5.5 ft. (1.7m).

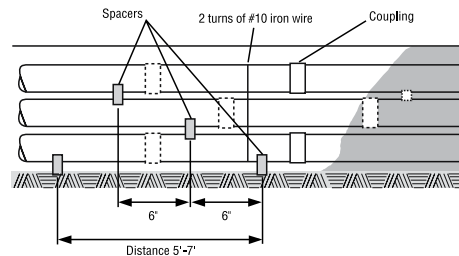

Backfilling

Backfill with regular excavated soil after the concrete has set.

Concrete Encased Tier-by-Tier Installation

The advantage of this method is the production of a solid, void-free concrete envelope. Simply pour each tier independently.

Trench Bottom

After grading the trench, place a foundation of 3" of concrete on the bottom. It should be smooth and graded.

Bank Assembly

Lay the bottom tier of ducts on the concrete base. Ducts should be spaced with wooden combs (two per duct length). Concrete the first tier level to the top of the comb. Remove combs and fill the voids. Light tamping will ensure an even surface. Repeat this sequence until the bank is built up.

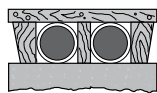

Type of wood comb used.

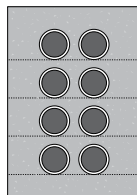

Cross-section of tier-by-tier method.

Concreting

If the concrete is allowed to set before assembling the next tier, the concrete will be stronger and more dense and the ducts will be aligned straighter. One problem with this method is that the bank will be in a series of layers and therefore more likely to heave and separate under frost conditions. If successive tiers are laid before the concrete has set, a satisfactory bond will be achieved by tamping the dry concrete.

Backfilling

Backfill with regular excavated soil when the bank is complete.

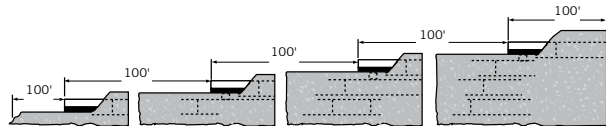

Duct is usually laid in 100' sections once the trench is excavated. Therefore, concreting can be a continuous process.

Direct Burial Installation

Trench Bottom

The trench bottom should provide a continuous, firm and uniform support for the duct bank construction. Care should be taken to avoid lumps, ridges, depressions and stones causing "point" contacts or uneven bearing.

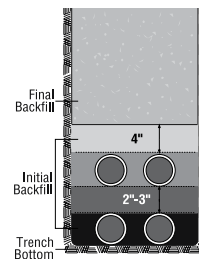

Rock or Shale

Excavate 3" below the desired depth and bring the trench back to grade with selected tamped soil. This will provide the duct with a uniform bedding surface.

Unstable Soils

Tests should be conducted to establish the soil strength in marshy or swampy areas. It may be necessary in these conditions to dig deeper and refill with crushed stone or gravel, or to employ mats, timbers or a concrete base.

Placement of Duct

After the first tier of ducts is installed, backfill and compact as outlined below. If wood combs are employed for spacing, remove them as the backfill is placed and tamped. Then begin the next tier.

Initial Backfilling

1. Fit side and centre to the top of the ducts. Use a hand tamper only to tamp firmly.
2. Backfill over the duct to the required thickness (see note) and tamp firmly, using only a hand tamper.

Final Backfilling

When the last tier is placed, hand-place the backfill to 4" over the duct with soil that does not contain stones larger than 3/8". Hand-tamping of this layer is optional, depending on the specifications.

From this point, backfill may be completed by hand or by pneumatic tamping in layers from 4" to 12" depending on the degree of compaction desired.

When placing backfill by machine, avoid the use of large rocks until a protective layer (minimum of 12") is established.

Note: In direct burial, no spacer should be used with Type 2; spacers provide "point" support instead of the continuous bed required. Backfill thickness between ducts is usually 2" to 3".

CSA Type II

Dimension (in)	10' L Belled		20' L Belled		Wgt./100' (lbs)
	Product Code	Ft./Crate	Product Code	Ft./Crate	
2	008220	2,460	008221	4,920	33.7
3	008230	1,120	008231	2,240	61.2
3-1/2	008235	810	008236	1,620	77.3
4	008240	630	008241	1,260	99.2
5	008250	430	008251	860	159.6
6	008260	280	008261	560	226.6

CSA Type II Split Duct

Dimension (in)	Product Code	Ft./Crate	Weight/100' (lbs)
2	008222	2,460	33.7
3	008232	1,120	61.2
3-1/2	008237	810	77.3
4	008000	630	99.2
5	008252	430	159.6

Super Duct Dimensions in Inches

Duct Diameter	Minimum ID	Nominal Wall	Average OD
2	2.001	.082	2.250
3	3.000	.097	3.250
3-1/2	3.480	.109	3.730
4	3.941	.120	4.216
5	4.974	.153	5.299
6	5.896	.180	6.275

Super Duct Dimensions in Millimetres

Duct Diameter	Minimum ID	Nominal Wall	Average OD
50	50.83	2.08	57.15
75	76.20	2.46	82.55
90	88.39	2.77	94.74
100	100.10	3.05	107.09
125	126.34	3.89	134.60
150	149.76	4.57	159.39

PVC Coupling - Solvent Weld

Dimension (in)	Part Number	Product Code
2	SWC020	029001
2 (long)	SWC020L	029009
3	SWC030	029002
3-1/2	SWC035	029003
4	SWC040	029004
5	SWC050	029005
6	SWC060	029006



Polyethylene Coupling - Push Fit*

Dimension (in)	Part Number	Product Code
2	PFC020	029011
3	PFC030	029012
3-1/2	PFC035	029013
4	PFC040	029014
5	PFC050	029015
6	PFC060	029016



* Suitable for concrete-encased applications only

PVC 5° Coupling - Solvent Weld

Dimension (in)	Part Number	Product Code
2	5ACS20	029041
3	5ACS30	029042
3-1/2	5ACS35	029043
4	5ACS40	029044
5	5ACS50	029045
6	5ACS60	029046



Polyethylene 5° Coupling - Push Fit*

Dimension (in)	Part Number	Product Code
2	5APF20	029620
3	5APF30	029030
3-1/2	5APF35	029502
4	5APF40	029998
5	5APF50	029050



* Suitable for concrete-encased applications only

Expansion Joint

Dimension (in)	Part Number	Product Code
2	EXPJ20	029151
3	EXPJ30	029152
3-1/2	EXPJ35	029153
4	EXPJ40	029154



Reducer Coupling – Solvent Weld

Dimension (in)	Part Number	Product Code
3 x 2	RC3020	029021
3-1/2 x 2	RC3520	029039
3-1/2 x 3	RC3530	029022
4 x 2	RC4020	029023
4 x 3	RC4030	029024
4 x 3-1/2	RC4035	029025
5 x 4	RC5040	029026
6 x 4	RC6040	029027



Split Wye – Solvent Weld

Dimension (in)	Part Number	Product Code
2	SPLY20	029463
3	SPLY30	029052
3-1/2	SPLY35	029053
4	SPLY40	029054



PVC Bell Ends

Dimension (in)	Part Number	Product Code
2	BELL20	029061
3	BELL30	029062
3-1/2	BELL35	029063
4	BELL40	029064
5	BELL50	029065
6	BELL60	029066



Terminator with Knock-Out Plugs

Dimension (in)	Part Number	Product Code
3	TERM30	029826
3 1/2	TERM35	029523
4 (with holes)	TERM40H	029822
4 (no holes)	TERM40W	029827

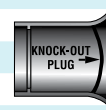

Cap – Solvent Weld

Dimension (in)	Part Number	Product Code
2	SWCA20	029071
3	SWCA30	029072
3-1/2	SWCA35	029073
4	SWCA40	029074
5	SWCA50	029075
6	SWCA60	029076



90° Long Sweep Bend

Dimension (in)	Part Number	Product Code
2 x 24 R	902024	029091
2 x 36 R	902036	029092
2 x 60 R	902060	029036
3 x 24 R	903024	029055
3 x 36 R	903036	029093
3 x 60 R	903060	029134
3-1/2 x 24 R	903524	029123
3-1/2 x 36 R	903536	029094
3-1/2 x 60 R	903560	029135
4 x 24 R	904024	029047
4 x 36 R	904036	029095
4 x 60 R	904060	029096
5 x 42 R	905042	029097
5 x 60 R	905060	029037
6 x 60 R	906060	029098



45° Long Sweep Bend

Dimension (in)	Part Number	Product Code
2 x 24 R	452024	029111
2 x 36 R	452036	029112
3 x 24 R	453024	029082
3 x 36 R	453036	029113
3-1/2 x 36 R	453536	029114
4 x 24 R	454024	029128
4 x 36 R	454036	029115
4 x 60 R	454060	029116
5 x 42 R	455042	029117
6 x 60 R	456060	029118



22 1/2° Long Sweep Bend

Dimension (in)	Part Number	Product Code	Product Code
3 x 36 R	223036	029085	*129085
4 x 36 R	224036	029204	*129204
5 x 42 R	225042	029249	*129249
5 x 30 R	-	029257	-
3 x 150 R	-	029536	-
4 x 150 R	-	029596	-



*Product Codes are for the Prairie Provinces only.
Note: Special radius bends are available upon request.

Tapered Plug

Dimension (in)	Part Number	Product Code
2	PLUG20	029131
3	PLUG30	029132
3-1/2	PLUG35	029133
4	PLUG40	029078
5	PLUG50	029079
6	PLUG60	029136



Universal Pipe Plug

Dimension (in)	Part Number	Product Code
2 & 2-1/2	UPP35	029386
3 & 3-1/2	UPP45	029387
4	UPP55	029388
5	UPP60	029389
6	UPP65	029390



Female Adapter

Dimension (in)	Part Number	Product Code
2	FEMA20	029141
3	FEMA30	029142
3-1/2	FEMA35	029143
4	FEMA40	029144
5	FEMA50	029145
6	FEMA60	029146



Conduit to Duct Adapter

Dimension (in)	Part Number	Product Code
2	ARIG20	029181
2 (long)	ARIG20L	029188
3	ARIG30	029182
3-1/2	ARIG35	029183
4	ARIG40	029184
5	ARIG50	029185
6	ARIG60	029186



Note: Duct to RTRC Conduit Adapters are available on request.

Reducing Adapter Coupling – Duct to PVC Conduit

Dimension (in)	Part Number	Product Code
3 x 2	ARIG3020	029191
4 x 2	ARIG4020	029192
4 x 3	ARIG4030	029187



PVC Adapter Coupling – Asbestos Cement or Bituminous Fibre

Dimension (in)	Part Number	Product Code
3-1/2	ACFB35	029163
4	ACFB40	029164



Vertical-Lok Spacers

Size (inches)	BASE VERTICAL-LOK SPACERS						INTERMEDIATE VERTICAL-LOK SPACERS							
	Part Number	Product Code	A	B	H	G	Part Number	Product Code	C	D	E	F	G	H
2 x 1-1/2	BS3530	029566	3.04	4.25	0.63	3.94	IS3530	029550	1.52	1.50	3.95	3.95	3.94	0.63
2 x 2	BS3535	029567	3.04	4.25	0.63	4.47	IS3535	029551	2.03	2.06	4.48	4.48	4.47	0.63
2 x 3	BS3545	029568	3.04	4.25	0.63	5.44	IS3545	029552	3.00	3.03	5.45	5.45	5.44	0.63
3 x 1-1/2	BS4530	029585	3.00	5.84	0.88	5.12	IS4530	029582	1.50	1.45	5.15	5.12	5.12	0.88
3 x 2	BS4535	029570	2.97	4.78	0.88	5.63	IS4535	029554	2.00	1.88	5.64	5.63	5.63	0.88
3 x 3	BS4545	029571	3.00	4.81	0.88	6.63	IS4545	029555	3.00	2.88	6.66	6.63	6.63	0.88
4 x 1	BS5520	029586	3.00	5.32	0.88	5.63	IS5520	029583	1.00	1.03	5.66	5.63	5.63	0.88
4 x 1-1/2	BS5530	029573	3.00	5.31	0.88	6.13	IS5530	029557	1.50	1.39	6.13	6.14	6.13	0.88
4 x 2	BS5535	029574	3.06	5.38	0.88	6.63	IS5535	029558	2.00	1.88	6.64	6.63	6.63	0.88
4 x 3	BS5545	029575	3.06	5.38	0.88	7.63	IS5545	029559	3.00	2.90	7.64	7.64	7.63	0.88
5 x 1-1/2	BS6030	029587	3.00	5.84	0.88	7.37	IS6030	029584	1.68	1.69	7.37	7.37	7.37	0.88
5 x 2	BS6035	029577	3.13	5.94	0.88	7.88	IS6035	029561	2.25	2.15	7.89	7.89	7.88	0.88
5 x 3	BS6045	029578	3.19	6.00	0.88	8.69	IS6045	029562	3.06	2.96	8.70	8.70	8.69	0.88
6 x 1-1/2	BS6530	029579	3.02	6.38	0.88	8.21	IS6530	029563	1.50	1.38	8.24	8.22	8.21	0.88
6 x 2	BS6535	029580	3.02	6.38	0.88	8.72	IS6535	029564	2.00	1.89	8.74	8.73	8.72	0.88
6 x 3	BS6545	029581	3.00	6.38	0.88	9.75	IS6545	029565	3.00	2.90	9.77	9.77	9.75	0.88
* 8 x 2	BS8035	029293	3.00	7.25	*	10.80	* IS8035	029294	2.06	2.00	10.58	10.80	10.80	*

* Do not have rebar slots

* Do not have rebar slots

Intermediate Vertical-Lok Spacers (Duct Pipe Only)

Dimension (in)	Part Number	Product Code
* 4 x 1-1/2	IS5530D	029340
* 4 x 2	IS5535D	029341

* Not supplied with rebar holder slots.

Base Vertical-Lok Spacers (Duct Pipe Only)

Dimension (in)	Part Number	Product Code
* 4 x 1-1/2	BS5530D	029440
* 4 x 2	BS5535D	029441

* Not supplied with rebar holder slots.

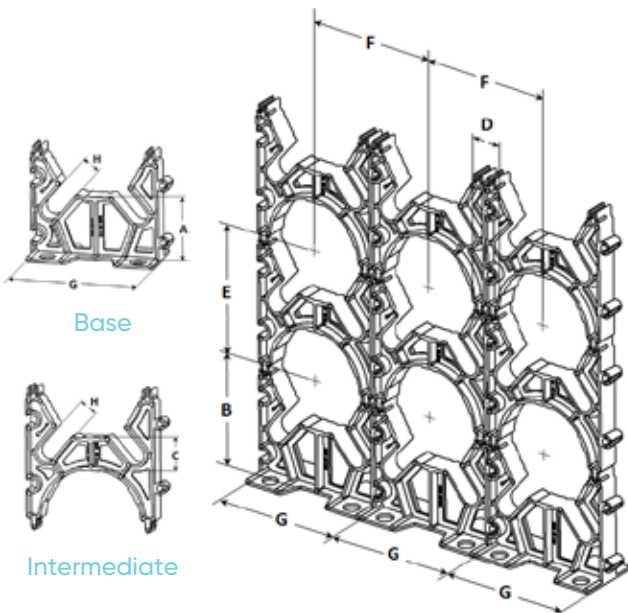

Monobloc Spacer Benefits for Telephone Duct:

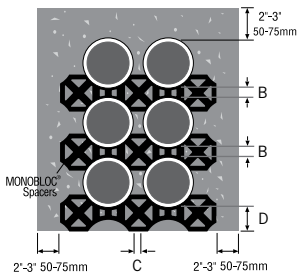

- lightweight; easy to handle and install
- weatherproof
- resilient at extremely low temperatures
- flexible, yet tough
- readily available in a wide range of sizes and configurations
- economical
- immune to corrosion attack
- approved by Bell Canada
- versatile, as they can be used as both a base & intermediate spacer

Selection Table (in inches)

Nominal Size (A)	Vertical Spacing (B)	Horizontal Spacing (C)	Ground Clearance (D)	Number of Ways (E)
2	1-1/2	1-1/2	3	2
3	1-1/2	1-1/2	3	2
3-1/2	1	1	2	2 - 3 - 4
4	1	1	2	1 - 2 - 3 - 4
4	1-1/2	1-1/2	3	2 - 3 - 4
4	2	2	3	1 - 2 - 3 - 4
4	3	3	3	2 - 3 - 4
4	3	3	4	2 - 3 - 4
4-1/2	2	2	3	1 - 2 - 3
5	1-1/2	2-1/8	3-5/8	1
5	1-1/2	1-1/2	3	2 - 3 - 4

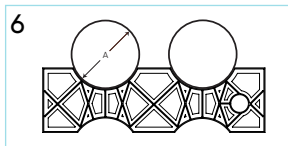
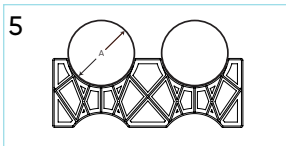
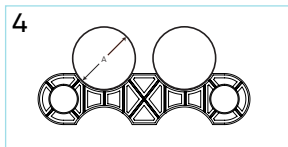
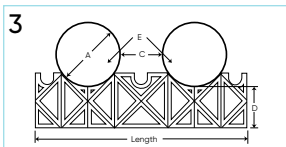
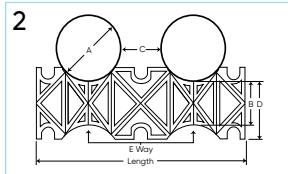
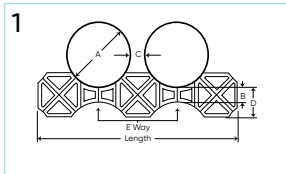

Monobloc Duct Spacers

Description (in) A, B, C, D	E	Product Code	Dimensional Drawing	F Length (in)
2 x 1-1/2 x 1-1/2 x 3	2 way	029473	5	7.9
3 x 1-1/2 x 1-1/2 x 3	2 way	029474	5	10.3
3-1/2 x 1 x 1 x 2	2 way	029860	4	12.4
3-1/2 x 1 x 1 x 2	3 way	029861	4	17.3
3-1/2 x 1 x 1 x 2	4 way	029479	1	20.9
4 x 1 x 1 x 2	1 way	029475	1	8.3
4 x 1 x 1 x 2	2 way	029476	1	13.5
4 x 1 x 1 x 2	3 way	029477	1	18.8
4 x 1 x 1 x 2	4 way	029478	1	24.2
* 4 x 1-1/2 x 1-1/2 x 3	2 way	029470	2	14.2
* 4 x 1-1/2 x 1-1/2 x 3	3 way	029471	2	20.0
* 4 x 1-1/2 x 1-1/2 x 3	4 way	029472	2	26.0
* 4 x 2 x 2 x 3	1 way	029480	2	8.3
* 4 x 2 x 2 x 3	2 way	029464	2	14.5
* 4 x 2 x 2 x 3	3 way	029465	2	20.7
* 4 x 2 x 2 x 3	4 way	029499	2	27.0
* 4 x 3 x 3 x 3 (Base)	2 way	029466	3	15.0
* 4 x 3 x 3 x 3 (Base)	3 way	029488	3	22.5
* 4 x 3 x 3 x 3 (Base)	4 way	029489	3	30.0
* 4 x 3 x 3 x 4	2 way	029469	2	15.0
* 4 x 3 x 3 x 4	3 way	029497	2	22.5
* 4 x 3 x 3 x 4	4 way	029498	2	30.1
4-1/2 x 2 x 2 x 3	1 way	029485	6	8.7
4-1/2 x 2 x 2 x 3	2 way	029486	6	15.5
4-1/2 x 2 x 2 x 3	3 way	029487	6	22.2
5 x 1-1/2 x 1-1/2 x 3	2 way	029494	5	16.2
5 x 1-1/2 x 1-1/2 x 3	3 way	029495	5	23.1
5 x 1-1/2 x 1-1/2 x 3	4 way	029496	5	30.0

* Spacers have provisions for re-bar. (re-bar slots)



Challenge:

4 lane highway
6,000 cars/hour
4,000 trucks/hour
Silt and clay

Solution:

SceptaCon™ Trenchless

The SceptaCon™ Solution

PVC raceway engineered for trenchless applications

SceptaCon is a water-tight PVC raceway system designed specifically for horizontal directional drilling (HDD) applications. No open-trenching, traffic interruptions or costly damage to roads and sidewalks.

With its slide-in spline locking system, SceptaCon comes together quickly – no special fusion equipment or training is needed. Assembled one pipe length at a time and then pulled underground, it eliminates the need for long strings of pipe on the jobsite. Able to link seamlessly with existing PVC conduit infrastructure, SceptaCon allows utilities to standardize on PVC throughout their entire electrical system.

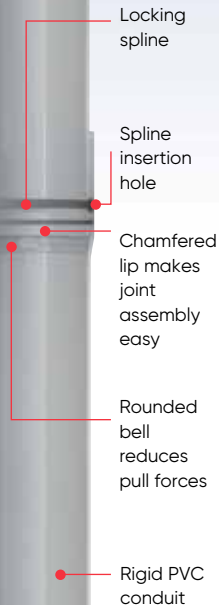

SceptaCon™ Trenchless Raceway Systems

SceptaCon is one of the first PVC systems designed for the rigors of trenchless applications. It links seamlessly to existing PVC conduit infrastructures and allows utility companies to standardize on PVC throughout their entire electrical systems.

SceptaCon's slide-in locking system and pre-installed, pre-lubricated gaskets allow contractors to create a water-tight seal by hand in seconds - in all temperatures - without having to worry about solvents or chemicals freezing or drying too quickly.

Its unique spline-lock snaps into a recessed opening, ensuring the spline won't get snagged during pull-through. SceptaCon's rounded bell shoulders slide easily past roots, rocks and other debris in the borehole, ensuring a smooth, easy installation. And because SceptaCon is made to the same high standards as our Scepter rigid PVC conduit, contractors and electrical utilities can be assured of the same level of quality - above ground and below.



No Cementing or Lubrication

SceptaCon's slide-in locking system and pre-installed, pre-lubricated gaskets allow contractors to create a water-tight seal by hand in seconds.

Outperforms Other PVC Products

SceptaCon's unique spline-lock snaps into a recessed opening, ensuring the spline won't get snagged during pull-through. SceptaCon's rounded bell shoulders slide easily past roots, rocks and other debris in the borehole, ensuring a smooth, easy installation.

No Fusion Required

Because SceptaCon's joints can be quickly joined by hand in seconds, crews don't need large, expensive fusion equipment or special training to create water-tight joints. In addition, SceptaCon can be assembled one pipe length at a time, then pulled underground, eliminating the need for long strings of pipe on the job.

Superior Performance

SceptaCon is made from durable schedule 40 PVC that's resistant to creasing, scoring or flattening when pulled past obstructions in the borehole, yet flexible enough to bend with underground twists and turns. SceptaCon remains round, unlike HDPE which can stretch and become oval.

Easy to Handle

SceptaCon is available in convenient 10' and 20' lengths that are light-weight, easy to handle and no problem to work with in all types of weather.

SceptaCon™ Raceway

Dimensions		Product Code	Product Code
in	mm	10'	20'
2	53	-	106421
3	78	106430	106431
4	103	106440	106441
5	129	106450	106451
6	155	106460	106461



FiberTel® HDPE Innerduct

IPEX Electrical Inc. is pleased to announce that FiberTel® High Density Polyethylene (HDPE) Innerduct is certified to CSA C22.2 No. 327 HDPE conduit for both SDR11 and SDR13.5 wall thicknesses. FiberTel is available in various colours and sizes and combines the features of flexibility, durability, lightweight and ease of installation.

Mechanically and chemically resistant to a host of environmental conditions, FiberTel is resistant to decomposition, oxidation, and hostile elements that cause damage to other materials. Used for communication, data, cable television, power and general purpose ducting, FiberTel is ideal for both short runs and cross-country distances. Always check for proper use and application with the local authority having jurisdiction before installation. A special feature of FiberTel is that it can be engineered to suit your needs. The wall thickness, diameter, color, resin type and coil lengths can all be specified to meet the requirements of your project.



Electrical CSA C22.2 No. 327

C

Durable

FiberTel is constructed of High Density Polyethylene offering a high tensile strength reducing elongation and stretching. This results in an increased lifespan and lower maintenance costs.

Weather Resistant

FiberTel features a unique formulation that protects it against the harmful effects of excessive ultraviolet rays. For above-ground installations, no special covering, coating or protection is required.

Sequential Printing

FiberTel coils and reels come complete with sequential footage printing on the pipe indicating how much footage is left after installation. This is a very convenient feature for people in the field!

Wall Surface

The smooth interior surface of FiberTel offers reduced friction making cables easier to pull.

Colour Coding

FiberTel is available in a multitude of colours. It can also be permanently marked with a single or triple stripe identification system. The coloured stripe is actually part of the pipe wall and will always remain visible, permanently identifying the pipe.

Quality Control

FiberTel is manufactured under strict quality control, ensuring that only top quality product leaves our manufacturing facilities. Our quality process extends from the raw material to the finished goods.

Weather Resistant

FiberTel features a unique formulation that protects it against the harmful effects of excessive ultraviolet rays. For above-ground installations, no special covering, coating or protection is required.

User Friendly

The flexibility of FiberTel allows for easy bending during installation. Breaking due to expansion and contraction is virtually eliminated. FiberTel can absorb sudden impact without suffering damage – even in extreme conditions.

Pull Strings and Mule Tapes

FiberTel is available with various types of pull strings or mule tapes upon request.

SDR11

Nominal Pipe Size	Average OD			Min. Avg Wall Thickness & Tolerance				
	Nom.	Min	Max	Thickness	+ Tolerance	Ins Dia.	Wgt	
in.	mm	mm	mm	mm	mm	mm	Kg/m	
1/2	12	21.34	21.20	21.40	1.94	0.51	16.30	0.13
3/4	20	26.67	26.60	26.80	2.42	0.51	20.73	0.19
1	25	33.40	33.30	33.50	3.04	0.51	26.21	0.30
1-1/4	32	42.16	42.00	42.30	3.83	0.51	33.31	0.46
1-1/2	40	48.26	48.10	48.40	4.39	0.53	38.27	0.60
2	50	60.33	60.20	60.50	5.48	0.66	47.91	0.94
2-1/2	65	73.03	72.80	73.20	6.64	0.80	57.92	1.38
3	75	101.60	88.70	89.10	8.08	0.97	70.60	2.05
4	100	114.30	113.80	114.80	10.39	1.25	90.52	3.39

SDR13.5

Nominal Pipe Size	Average OD			Min. Avg Wall Thickness & Tolerance				
	Nom.	Min	Max	Thickness	+ Tolerance	Ins Dia.	Wgt	
in.	mm	mm	mm	mm	mm	mm	Kg/m	
1/2	12	21.34	21.20	21.40	1.58	0.51	17.02	0.11
3/4	20	26.67	26.60	26.80	1.98	0.51	21.63	0.16
1	25	33.40	33.30	33.50	2.47	0.51	27.33	0.25
1-1/4	32	42.16	42.00	42.30	3.12	0.51	34.73	0.39
1-1/2	40	48.26	48.10	48.40	3.57	0.51	39.93	0.51
2	50	60.33	60.20	60.50	4.47	0.54	50.18	0.79
2-1/2	65	73.03	72.80	73.20	5.41	0.65	60.68	1.15
3	75	101.60	88.70	89.10	6.59	0.79	73.95	1.70
4	100	114.30	113.80	114.80	8.47	1.02	94.83	2.82

Other non-CSA approved options are also available

- Wall thicknesses (Sch 40/80, SDR9, SDR15.5, SDR17)
- Internal and/or external ribs

Contact your Sales Rep to find out more about our CSA and non-CSA approved HDPE pipe products.

Installation

FiberTel pipe should be cut square using a hand or power saw. All burrs and cuttings must be removed to ensure a good reliable joint.

Joining FiberTel requires no sophisticated tools or special equipment. FiberTel can be heat-fused using standard equipment or joined with compression fittings.

FiberTel can be installed in an open trench, direct plowed, or installed using various trenchless technology methods.

Polyethylene is a thermoplastic which expands and contracts with temperature changes. If pipe is expected to contract after it is installed, it should be snaked in the trench, or if expansion is anticipated, it should be installed straight.

The bottom of the trench and the backfill materials must be free of stones, rocks or debris that may damage the pipe.





Register your Pocket Pro today!

Fax this form to (905) 844-1504 and we'll add you to our mailing list.



Tel: (289) 881-0120
Toll Free: (866) 473-9462



IPEX
1425 North Service Rd. E.
Unit 3
Oakville, Ontario L6H 1A7



Fax: (905) 844-1504



Website: ipexna.com

PLEASE PRINT

Company

Name

Title

Address

City

Province

Postal Code

Phone

ext.

Fax

E-mail / Website

This is a:

- Home Address Business Address Jobsite Address

Business Type:

(check 1 or 2 that best apply)

Company Classification:

- Distributor/Wholesaler
 Engineering Firm
 Contractor
 Government
 OEM - Products Manufactured: _____
 Other: _____

SIC or industry sector: _____

My primary markets are (check all that apply):

- Commercial Utility
 Residential OEM
 Industrial Institutional
 Other: _____

SALES AND CUSTOMER SERVICE

Customers call IPEX Electrical Inc.

Toll free: (866) 473-9462

www.ipexna.com

About IPEX by Aliaxis

As leading suppliers of thermoplastic piping systems, IPEX by Aliaxis provides our customers with some of the world's largest and most comprehensive product lines. All IPEX by Aliaxis products are backed by more than 50 years of experience. With state-of-the-art manufacturing facilities and distribution centers across North America, we have earned a reputation for product innovation, quality, end-user focus and performance.

Markets served by IPEX by Aliaxis products are:

- Electrical systems
- Telecommunications and utility piping systems
- Industrial process piping systems
- Municipal pressure and gravity piping systems
- Plumbing and mechanical piping systems
- Electrofusion systems for gas and water
- Industrial, plumbing and electrical cements
- Irrigation systems
- PVC, CPVC, PP, PVDF, PE, ABS, and PEX pipe and fittings

Products are manufactured by IPEX Electrical Inc.

Cor-Line®, Inexo®, JBox™, Kwikon®, Monobloc®, SceptaCon™, Sceptalight™ and SuperDuct® are trademarks of IPEX Branding Inc.

www.ipexna.com

This literature is published in good faith and is believed to be reliable. However, it does not represent and/or warrant in any manner the information and suggestions contained in this brochure. Data presented is the result of laboratory tests and field experience. A policy of ongoing product improvement is maintained. This may result in modifications of features and/or specifications without notice