

RIGID PVC CONDUIT & FITTINGS



Scepter[®]
Rigid PVC Conduit & Fittings



ELECTRICAL SYSTEMS

RIGID PVC CONDUIT & FITTINGS

• 1/2" – 8"

IPEX
by aliaxis

We build tough products for tough environments[®]

TABLE OF CONTENTS

SCEPTER ELECTRICAL PRODUCTS.....	2
Applications.....	3
Advantages.....	4
Installation.....	7
Expansion & Contraction.....	9
Standards & Sample Specifications.....	13
SCEPTER PRODUCT CATALOGUE.....	14
Conduit.....	14
Elbows.....	15
Pipe straps.....	16
Clamps & wall spacers.....	17
Couplings.....	17
Adapters.....	18
Bushings.....	19
End caps.....	19
End bells.....	20
O-ring expansion joints.....	20
Expansion & deflection fitting assemblies.....	20
One piece expansion joints.....	21
Strain relief connectors.....	21
Conduit cements & primer.....	21
Interlocking spacers.....	23
Access fittings.....	24
Pull elbows.....	27
Service entrance fittings.....	27
Meter offsets.....	27
Meter hubs.....	27
Expansion joints.....	28
Slip meter risers.....	28
F-Series gang boxes.....	28
Octagonal boxes.....	29
F-Series gang plates.....	30
F-Series gang weatherproof covers.....	31
Boxes.....	32
Junction box adapters.....	34
SCEPTER JBOXES.....	36
EPR KITS FOR CONDUIT REPAIR.....	42

SCEPTER CONDUIT & FITTINGS

SCEPTER Conduit & Fittings preferred for the LONG RUN

This manual provides the most comprehensive information about Scepter® PVC systems – from basic raw material to installation characteristics of the finished product. Written with the engineer, contractor and distributor in mind, it is based on laboratory test results and IPEX's many years of field experience.

At IPEX, we have been extruding Scepter PVC conduit and molding Scepter PVC fittings since 1951. We formulate our own compounds, maintain strict quality control during production, and offer the most comprehensive line of electrical products throughout North America.

More important, our commitment to our customer extends beyond the sale. Quality control and thorough jobsite field reports have earned Scepter a reputation for product quality and service excellence.

Engineers, electricians, contractors, specifiers and utilities have realized for many years the advantages of PVC. Whether exposed, concealed in walls, encased in concrete, or directly buried, IPEX electrical products are preferred for the long run.



APPLICATIONS

- UTILITIES
- COMMUNICATIONS
- AIRPORTS
- CABLE
- SUBWAYS
- CAR WASHES
- PARKING GARAGES
- FISH PLANTS
- STEEL MILLS
- MARINAS
- BRIDGES AND TUNNELS
- MINES
- STREET AND HIGHWAY LIGHTING
- RESIDENTIAL APPLICATIONS
- WATER TREATMENT PLANTS
- SEWAGE TREATMENT PLANTS
- PULP AND PAPER INDUSTRIES
- AGRICULTURAL, DAIRY, HOGS, CATTLE, CHICKEN, ETC.
- FOOD PROCESSING PLANTS



SCEPTER CONDUIT & FITTINGS

ADVANTAGES

LABOR SAVINGS

Compared to metal, PVC products reduce labor on a typical installation by up to two-thirds. The reason? PVC is easy to work with. It can also be cut and joined without the usual pipe vices, cutters, threading equipment and reamers associated with metal conduit.

LIGHTWEIGHT CONDUIT

Scepter Rigid PVC Conduit is one-half the weight of aluminum and one-sixth the weight of steel. As a result, handling and installation are easier and faster, reducing labor costs.

EASY JOINING

Solvent cementing is all that is required, eliminating the need for power-threading machines, pipe vices and cutting equipment. A hacksaw or carpenter's saw is the only equipment required. IPEX Cements and Primers are UL GREENGUARD Gold certified.

EASY WIRE PULLS

PVC's exceptionally smooth interior surface greatly reduces the amount of friction while pulling conductors/ wires through long runs, even with 90° bends. A large pull-rope and wire-pulling lubricant should be used when pulling all conductors and wires.

STRENGTH

Scepter Rigid PVC Conduit offers both high impact and high tensile strength. And, even in cold temperatures, exceeds all CSA and UL standards.

SCEPTER RIGID PVC CONDUIT SCHEDULE 40

Size		UL Impact Test	
in	mm	@ 72°F	@ 23°C
1/2	12	50 ft.lbs	68 joules
3/4	20	80 ft.lbs	109 joules
1	25	100 ft.lbs	136 joules
1-1/4	32	120 ft.lbs	163 joules
1-1/2	40	150 ft.lbs	204 joules
2	50	190 ft.lbs	258 joules
2-1/2	65	210 ft.lbs	285 joules
3 - 6	75-150	220 ft.lbs	298 joules
8	75-150	n/a	n/a

NONCORRODING

PVC is immune to damage from naturally corrosive soil conditions, as well as electro-chemical and galvanic corrosion. This ensures lower maintenance costs and superior performance.

NONCONDUCTING

Scepter Rigid PVC Conduit pipe and fittings are nonsparking and nonconducting, thereby eliminating the most dangerous 'second point of contact' and 'phase to ground' faults. The use of a separate grounding conductor in a Scepter PVC conduit system gives a complete and positive ground for the whole system.

CHEMICAL RESISTANCE

One of the greatest benefits of PVC is its excellent chemical resistance. It resists attack by acids, alkalis, salt solutions, and many other types of chemicals. For more information on PVC and chemical resistance, refer to the IPEX Chemical Resistance Guide.

LONG LIFE

Scepter Rigid PVC Conduit pipe and fittings retain their original properties after years of exposure to heat and weather. In addition, resistance to fungi, bacterial action, rodents, termites and corrosive agents ensures a long, trouble-free life for PVC conduit installed indoors or outdoors.

CONCRETE TIGHT

Scepter Rigid PVC Conduit pipe and fittings are designed and engineered to be concrete tight in all weather conditions.

FIRE RESISTANT

As a building material PVC offers outstanding fire performance characteristics. PVC will not burn unless an external flame source is applied, and will not sustain ignition once the flame source is removed. PVC has a flash ignition temperature of 850°F.

IPEX Compound	Flame Spread	Smoke Developed	Fuel Contribution
1/8" thickness	10 - 20	225 - 270	0
3/4" thickness	10 - 20	300 - 390	0

SCEPTER CONDUIT & FITTINGS

ADVANTAGES

SUITABLE FOR DIRECT BURIAL

PVC is suitable for direct burial and requires no extra protection when installed in accordance with local inspection authority guidelines. The usual care regarding trenches and backfilling should be respected.

ONE-SOURCE SPECIFICATION

IPEX offers a full range of PVC fittings and accessories. As a result, one-material specifying is possible.

QUALITY CONTROL

In addition to our rigorous quality control testing, IPEX product carries third-party certification by UL and CSA.

**DOWNLOAD
THE SCEPTER APP**

The **CALCULATOR** for
Expansion Joints and
Support Spacing

Check it out!



The calculation process is simple...

INSTALLATION

SUPPORT

Due to PVC's light weight, support spacing is different than that used with metal conduits. Supporting straps should NOT be firmly tightened, to allow for linear movement. The maximum allowable support spacing, per the National Electrical Code Article 352.30 (B) is as follows:

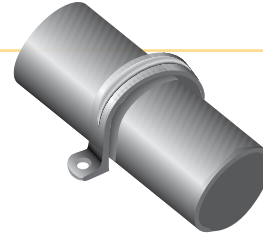

SUPPORT SPACING

Scepter Rigid PVC Conduit pipe and fittings are designed and engineered to be concrete tight in all weather conditions.

Nominal Conduit Diameter inches	National Electrical Code Max. Support Spacing feet
1/2	2-1/2
3/4	2-1/2
1	2-1/2
1-1/4	4
1-1/2	4
2	5
2-1/2	6
3	6
3-1/2	7
4	7
5	7
6	8
8	8



MAX OPERATING TEMPERATURE

The National Electrical Code (NEC) allows the use of rigid nonmetallic conduit (RNC) and fittings in locations where ambient temperatures are not in excess of 122°F.

CUTTING

Scepter Rigid PVC Conduit can be easily cut on the jobsite by using a hacksaw, carpenter's saw or PVC conduit cutters. For larger sizes of conduit, the use of a mitre box is also recommended to ensure a square cut.

SCEPTER CONDUIT & FITTINGS

INSTALLATION

SOLVENT CEMENTING

After cutting Scepter Rigid PVC Conduit, remove all sharp edges or burrs from the inside of the conduit with a knife. Thoroughly clean the end of the pipe and inside the fitting with a rag or pipe cleaner. Check the pipe and fitting for a dry fit before cementing. Apply a generous amount of IPEX solvent cement to both surfaces; slide together and give a quarter turn to ensure the solvent is spread evenly on the material. Hold together for a few seconds until the joint is made.

Usually the solvent-cemented joint will be strong enough to install immediately. However, in climates with low temperatures or areas with high humidity, extra time may be required before moving the pipe for permanent installation. Solvent-cemented joints appear to "set up" instantly, but will take up to 24 hours to cure properly. After this time, the solvent-cemented joint has completely cured and is waterproof. For extreme cold weather installations, the use of IPEX PVC Primer is recommended. Normal installation temperatures are between 40°F and 110°F, however, high strength joints have been made at temperatures as low as -15°F with quality cements. In these extreme conditions the cement must be kept warm to prevent excessive thickening and gelation in cold weather.

IPEX Cements and Primers are UL GREENGUARD Gold certified and are available in half-pint (250ml), pint (500ml), quart (1-litre) and gallon (4-litre) containers. The shelf life of conduit cement and primer is 3 years from the date of manufacture. The date code stamped on the bottom of the can is the date of manufacture, not the expiry date. Always verify that the cement is within this 3-year time frame before using. To search which products are certified and view/download their certificates, please visit the SPOT UL website.

BENDING

PVC is a thermoplastic material that, when heated, becomes soft and pliable. As a result, its shape can be altered.

A flameless heat source is recommended to heat the pipe. AN OPEN FLAME SHOULD NOT BE USED. An electric unit or an infra-red propane unit is recommended for heating the pipe.

The necessary temperature for bending Scepter Rigid PVC pipe is 260°F. The pipe must be heated evenly over an area approximately ten times the diameter of the pipe before any attempt at bending is made. Bending the pipe when it has not been thoroughly heated will cause the pipe to "kink." With proper care and a little practice, the bend will form easily.

Cooling the pipe with cold air or water will cause "spring back." Allow a few extra degrees of overbending to compensate for this phenomenon. The maximum bending radius shall be six times the internal diameter according to the National Electrical Code.

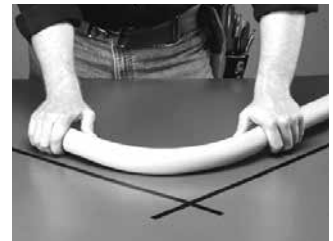

EXPANSION AND CONTRACTION

USING EXPANSION JOINTS

It is equally important to know when to install an expansion joint as it is to know how to correctly install the expansion joint. Expansion joints are required when the temperature change is greater than 25°F. Scepter Rigid PVC Conduit has a coefficient of linear expansion of 3.6×10^{-4} in./ft./°F. Generally, a 100 ft. run of PVC conduit will undergo a change in length of 3.6 inches for every 100°F temperature change.

For conduit installed indoors, the range of expansion and contraction can be calculated using the maximum air temperature plus the heat contributed by the conductors inside the conduit and the minimum air temperature expected. Expansion joints are not required indoors unless there are widely varying temperatures such as the attic of a building.

Conduit installed outdoors, exposed to direct sunlight, will be considerably hotter than the air temperature. As a guideline in this case, add 27°F to the temperature change. Expansion joints should be installed to allow for all anticipated temperature changes.

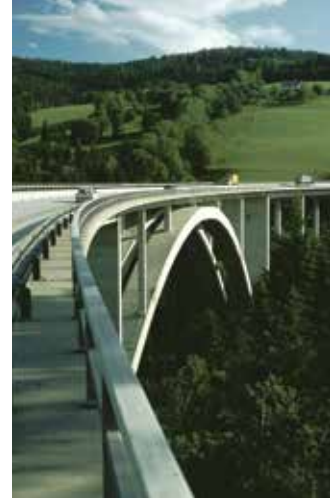

EXPANSION FORMULA

By using the following formula and the chart below, the total expected expansion in a run can be easily determined:

$$^{\circ}\text{F Total Expansion (in.)} = \text{length of run (ft.)} \times \text{temperature change (}^{\circ}\text{F)} \times 0.00036$$

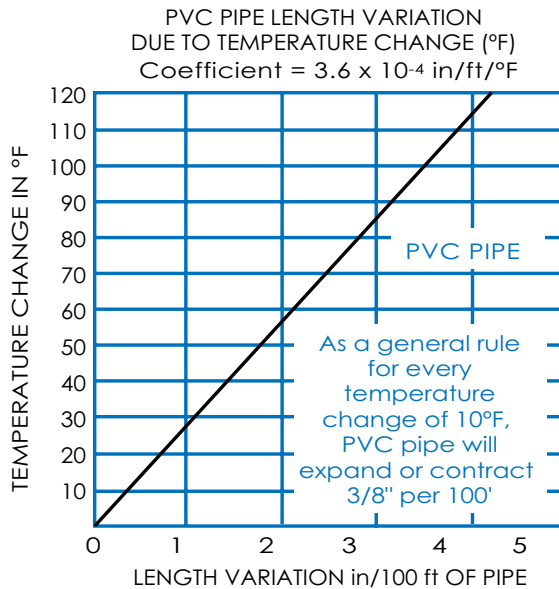

SCEPTER CONDUIT & FITTINGS

EXPANSION AND CONTRACTION

NUMBER OF EXPANSION JOINTS REQUIRED – TRY OUR NEW SCEPTER APP (see pg 8)

Use the following equation to determine the number of expansion joints needed for a Scepter Rigid PVC Conduit installation:

$$\text{Number of joints} = \frac{\text{total expansion (mm or in)}}{E}$$

E = Expansion joint travel length 4" or 8" depending on diameter.

Always round up to the next whole number.

The Scepter App allows you to calculate the number of joints required and the recommended support spacing for runs of conduit in a matter of seconds.

SETTING THE PISTON OPENING

The expansion joint must be installed to allow for expansion and contraction of the conduit run. On a cold day, if an expansion joint is installed completely closed with the piston bottomed, there is no room for expansion when the conduit is warmed. If it is installed open to the maximum on a hot day, the expansion joint will pull apart when cooled.

The correct piston opening for any installation condition can be easily determined using the formula below.

$$\text{Piston setting} = \text{compressed length} + \left(\frac{\text{max. temperature} - \text{installation temperature}}{\text{max. temperature} - \text{min. temperature}} \right) \times E$$

Formula can be used for both metric and imperial measurements.

Size (in)	Compressed Length (in)	Travel (in)
1/2	8.00	4
3/4	8.00	4
1	8.50	4
1-1/4	9.00	4
1-1/2	9.00	4
2	9.25	4
2-1/2	14.25	8
3	14.25	8
3-1/2	14.90	8
4	14.90	8
5	26.00	8
6	26.00	8

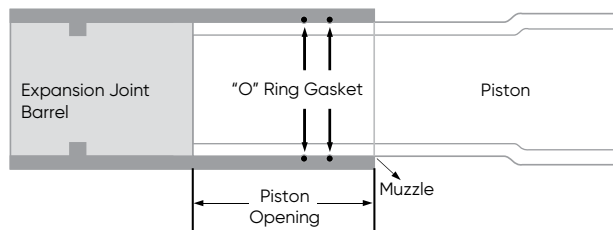

INSTALLATION OF EXPANSION JOINTS

USING EXPANSION JOINTS



Proper functioning of an expansion joint depends on three procedures:

1. The correct placement of the expansion joint.
2. The proper installation of Scepter Rigid PVC Conduit and the expansion joint.
3. The proper placement and fastening of support straps.

Legend

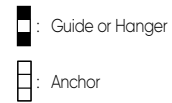

ONE EXPANSION JOINT - FIGURE 1

If only one expansion joint is needed between two boxes, the barrel of the joint should be rigidly fastened close to the first box. Scepter Rigid PVC Conduit should then be loosely supported with straps, allowing the conduit to move freely as it expands and contracts.

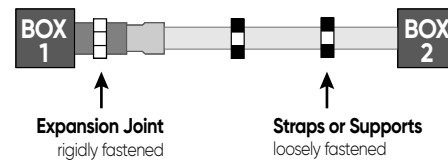

TWO EXPANSION JOINTS - FIGURE 2

If two expansion joints are needed, the joints should be firmly fastened back to back at the centre of the run. Scepter Rigid PVC Conduit should be loosely supported with straps, allowing the conduit to move freely as it expands and contracts.

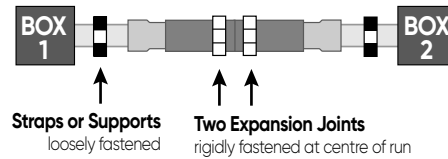

TWO EXPANSION JOINTS (ALTERNATIVE) - FIGURE 3

Alternatively, the centre of the run and the two expansion joints (located at the boxes) should be rigidly fastened. All other support straps should be loosely fastened.

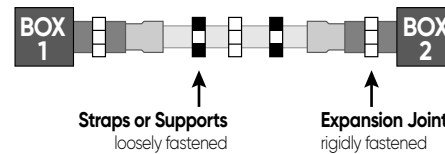

THREE OR MORE EXPANSION JOINTS - FIGURE 4

If more than two joints are needed in a very long run, they should be put in a series, one after the other. Each barrel must be rigidly fastened while conduit is loosely supported with straps allowing the conduit to move freely as it expands and contracts.

When installed in a series, each section acts independently of the other. Spacing of conduit supports must be in accordance with Section 12-1114 of the Canadian Electrical Code or NEC Article 347-8. (See Table on Support Spacing)

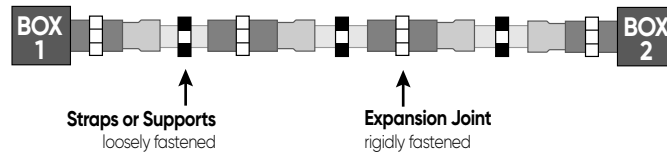

SCEPTER CONDUIT & FITTINGS

INSTALLATION OF EXPANSION JOINTS

INSTALLATION RECOMMENDATIONS

- Expansion joints should be mounted so the piston can travel in a straight line in the barrel. If the alignment is not straight, the piston will bind, preventing the joint from functioning correctly.
- The expansion joint barrel should be clamped tight, but the conduit mounted loose enough in its hangers to allow for movement as it expands and contracts.
- Scepter nonmetallic straps are correctly sized and designed for proper support, and must be used to secure the conduit.
- When expansion joints are used in a vertical position, the piston should be mounted in a downward position so dirt cannot deposit between the barrel and piston at the muzzle of the expansion joints.

COMMON MISTAKES

Three common mistakes are:

1. Forgetting to use expansion joints.
2. Not using enough expansion joints.
3. Overtightening of support straps.

It is more cost effective to use more expansion joints than needed, rather than too few. It is difficult to correct the problem after conductors are installed and in service. Failure to accommodate expansion/contraction may result in pipe fracture.



STANDARDS AND SAMPLE SPECIFICATIONS

LISTINGS

Scepter Rigid PVC Conduit conforms to these standards:

CSA C22.2 No. 211.2

CSA C22.2 No. 211.0

UL Listed-UL651

Sunlight Resistant

Rated for use with 90°C conductors

NEMA TC2

Corps. of Engineers Spec. CE 303:01

Military Spec, Federal Spec. WC 1094A

Scepter Rigid PVC boxes and fittings conform to these standards:

C-22.2 No. 85

UL Listed

UL514B - UL514C

IPEX Cements and Primers are

UL GREENGUARD Gold certified



APPROVALS

Canadian Electrical Code, Part 1 Rules 12-1100 – 12-1122

National Electrical Code NEC 1999 Article 347, NEC 2002 Article 352

SAMPLE SPECIFICATIONS

All wiring shall be installed in Rigid PVC conduit and secured to PVC boxes and cabinets by means of proper fittings. All boxes, access fittings and covers shall be furnished with threaded brass inserts, brass screws and PVC gaskets.

Rigid PVC fittings and junction boxes shall be used for all outlets, pull boxes and junction points. All PVC junction boxes shall be NEMA 1, 2, 3, 4, 4X, 12 and 13 rated and UL Listed for wet locations.

Exposed conduit shall be securely held in place by suitable hangers or straps with the maximum spacing of points for supports not exceeding those specified in the CEC or NEC. Except when embedded in concrete, rigid conduit pipe shall not be clamped tightly.

It shall be supported in such a manner as to permit adequate linear movement, allowing for expansion and contraction of conduit due to temperature change. Where a length is expected to be 1/4" or greater in a straight line between securely mounted items, rigid PVC expansion joints shall be installed in accordance with the manufacturer's recommendations.

Proper care shall be taken when field bending, to maintain the internal diameter and wall thickness of the conduit.

The contractor shall furnish and install Scepter Rigid PVC conduit pipe and fittings made by IPEX. Where engineer's specifications indicate Scepter products or equivalent, the equivalent shall be UL certified and accepted by the National Electrical Code. Due to broad manufacturing tolerances, all pipe and fitting products shall be of the same manufacturer.

SCEPTER PRODUCTS

PRODUCT SELECTION CHART & DIMENSIONS

Nominal Size inches	10' Product Code	20' Product Code	O.D. inches	I.D. inches	Min. Wall inches	Weight lbs./100	Standard 10' ft./crate
------------------------	---------------------	---------------------	----------------	----------------	---------------------	--------------------	---------------------------

Schedule 40 Heavy Wall in 10' or 20' Lengths

1/2	032405	032406	0.840	0.622	0.109	15	6,000
3/4	032407	032408	1.050	0.824	0.113	21	4,400
1	032410	032411	1.315	1.049	0.133	31	3,600
1-1/4	032412	032414	1.660	1.380	0.140	42	3,300
1-1/2	032415	032416	1.900	1.610	0.145	53	2,250
2	032420	032421	2.375	2.067	0.154	71	1,400
2-1/2	032425	032426	2.875	2.469	0.203	112	930
3	032430	032431	3.500	3.068	0.216	166	880
3-1/2	032435	032436	4.000	3.548	0.226	200	630
4	032440	032441	4.500	4.026	0.237	236	570
5	032450	032451	5.563	5.047	0.258	321	380
6	032460	032461	6.625	6.065	0.280	417	260

Schedule 80 Extra Heavy Wall in 10' or 20' Lengths

1/2	032505	032506	0.840	0.546	0.147	21	6,000
3/4	032507	032508	1.050	0.724	0.154	28	4,400
1	032510	032511	1.315	0.957	0.179	41	3,600
1-1/4	032512	032514	1.660	1.278	0.191	57	3,300
1-1/2	032515	032516	1.900	1.500	0.200	70	2,250
2	032520	032521	2.375	1.939	0.218	96	1,400
2-1/2	032525	032526	2.875	2.323	0.276	146	930
3	032530	032531	3.500	2.900	0.300	195	880
4	032540	032541	4.500	3.826	0.337	286	570
5	032550	032551	5.563	4.813	0.375	397	380
6	032560	032561	6.625	5.761	0.432	546	260

CONDUIT ELBOWS - SCHEDULE 40

Size inches	Part Number	Product Code	D inches	T inches	R inches
-------------	-------------	--------------	----------	----------	----------

90° Elbows Schedule 40 Standard Radius

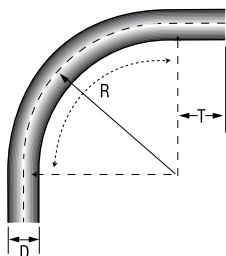

1/2	EE1090	068580	0.840	1.500	4.00
3/4	EE1590	068581	1.050	1.500	4.50
1	EE2090	068582	1.315	1.875	5.75
1-1/4	EE2590	068583	1.660	2.000	7.25
1-1/2	EE3090	068584	1.900	2.000	8.25
2	EE3590	056585	2.375	2.000	9.50
2-1/2	EE4090	068586	2.875	3.000	10.50
3	EE4590	068587	3.500	3.125	13.00
3-1/2	EE5090	068588	4.000	3.250	15.00
4	EE5590	068589	4.500	3.375	16.00
5	EE6090	068591	5.563	3.625	24.00
6	EE6590	068592	6.625	3.750	30.00

45° Elbows Schedule 40 Standard Radius

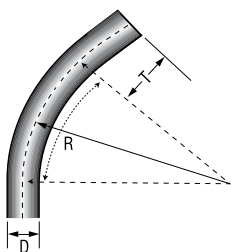

1/2	EE1045	068600	0.840	1.500	4.00
3/4	EE1545	068601	1.050	1.500	4.50
1	EE2045	068602	1.315	1.875	5.75
1-1/4	EE2545	068603	1.660	2.000	7.25
1-1/2	EE3045	068604	1.900	2.000	8.25
2	EE3545	068605	2.375	2.000	9.50
2-1/2	EE4045	068606	2.875	3.000	10.50
3	EE4545	068607	3.500	3.125	13.00
3-1/2	EE5045	068608	4.000	3.250	15.00
4	EE5545	068609	4.500	3.375	16.00
5	EE6045	068611	5.563	3.625	24.00
6	EE6545	068612	6.625	3.750	30.00

30° Elbows Schedule 40 Standard Radius

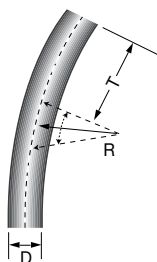

1/2	EE1030	068620	0.840	1.500	4.00
3/4	EE1530	068621	1.050	1.500	4.50
1	EE2030	068622	1.315	1.875	5.75
1-1/4	EE2530	068623	1.660	2.000	7.25
1-1/2	EE3030	068624	1.900	2.000	8.25
2	EE3530	068625	2.375	2.000	9.50
2-1/2	EE4030	068626	2.750	3.000	10.50
3	EE4530	068627	3.500	3.125	13.00
3-1/2	EE5030	068628	4.000	3.250	15.00
4	EE5530	068629	4.500	3.375	16.00
5	EE6030	068631	5.563	3.625	24.00
6	EE6530	068632	6.625	3.750	30.00

CONDUIT ELBOWS - SCHEDULE 40

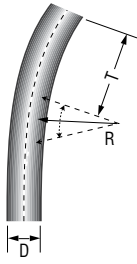

22-1/2° Elbows Schedule 40 Standard Radius

Size inches	Part Number	Product Code	D inches	T inches	R inches
1-1/2	EE1522	078580	1.900	2.000	8.25
2	EE2022	078581	2.375	2.000	9.50
2-1/2	EE2522	078582	2.875	3.000	10.50
3	EE3022	078583	3.500	3.125	13.00
3-1/2	EE3522	078584	4.000	3.250	15.00
4	EE4022	078585	4.500	3.375	16.00
5	EE5022	078586	5.563	3.625	24.00
6	EE6022	078587	6.625	3.750	30.00

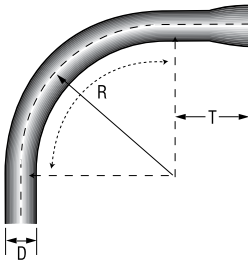

90° Elbows Schedule 40 - Integral Bell End

Size inches	Part Number	Product Code	D inches	T inches	R inches
1/2	EE1090B	068420	0.840	1.500	4.00
3/4	EE1590B	068421	1.050	1.500	4.50
1	EE2090B	068422	1.315	1.875	5.75
1-1/4	EE2590B	068423	1.660	2.000	7.25
1-1/2	EE3090B	068424	1.900	2.000	8.25
2	EE3590B	068425	2.375	2.000	9.50
2-1/2	EE4090B	068426	2.875	3.000	10.50
3	EE4590B	068427	3.500	3.125	13.00
3-1/2	EE5090B	068428	4.000	3.250	15.00
4	EE5590B	068429	4.500	3.375	16.00
5	EE6090B	068430	5.563	3.625	24.00
6	EE6590B	068431	6.625	3.750	30.00

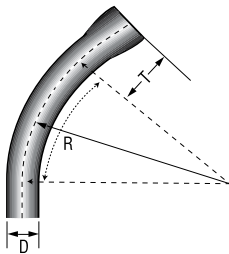

45° Elbows Schedule 40 - Integral Bell End

Size inches	Part Number	Product Code	D inches	T inches	R inches
1/2	EE1045B	068561	0.840	1.500	4.00
3/4	EE1545B	068562	1.050	1.500	4.50
1	EE2045B	068563	1.315	1.875	5.75
1-1/4	EE2545B	068564	1.660	2.000	7.25
1-1/2	EE3045B	068565	1.900	2.000	8.25
2	EE3545B	068566	2.375	2.000	9.50
2-1/2	EE4045B	068567	2.875	3.000	10.50
3	EE4545B	068568	3.500	3.125	13.00
3-1/2	EE5045B	068569	4.000	3.250	15.00
4	EE5545B	068570	4.500	3.375	16.00
5	EE6045B	068571	5.563	3.625	24.00
6	EE6545B	068572	6.625	3.750	30.00

CONDUIT ELBOWS - SCHEDULE 80

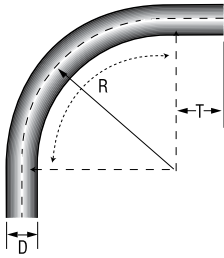

Size inches	Part Number	Product Code	D inches	T inches	R inches
90° Elbows Schedule 80 Standard Radius					
1/2	80EE1090	068690	0.840	1.500	4.00
3/4	80EE1590	068691	1.050	1.500	4.50
1	80EE2090	068692	1.315	1.875	5.75
1-1/4	80EE2590	068693	1.660	2.000	7.25
1-1/2	80EE3090	068694	1.900	2.000	8.25
2	80EE3590	068695	2.375	2.000	9.50
2-1/2	80EE4090	068696	2.875	3.000	10.50
3	80EE4590	068697	3.500	3.125	13.00
4	80EE5590	068698	4.500	3.375	16.00
5	80EE6090	068699	5.563	3.625	24.00
6	80EE6590	068700	6.625	3.750	30.00

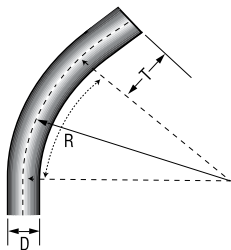

Size inches	Part Number	Product Code	D inches	T inches	R inches
45° Elbows Schedule 80 Standard Radius					
1/2	80EE1045	068810	0.840	1.500	4.00
3/4	80EE1545	068811	1.050	1.500	4.50
1	80EE2045	068812	1.315	1.875	5.75
1-1/4	80EE2545	068813	1.660	2.000	7.25
1-1/2	80EE3045	068814	1.900	2.000	8.25
2	80EE3545	068815	2.375	2.000	9.50
2-1/2	80EE4045	068816	2.875	3.000	10.50
3	80EE4545	068817	3.500	3.125	13.00
4	80EE5545	068818	4.500	3.375	16.00
5	80EE6045	068819	5.563	3.625	24.00
6	80EE6545	068820	6.625	3.750	30.00

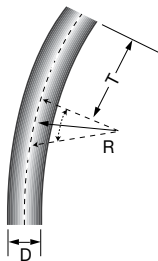

Size inches	Part Number	Product Code	D inches	T inches	R inches
30° Elbows Schedule 80 Standard Radius					
1/2	80EE1030	068550	0.840	1.500	4.00
3/4	80EE1530	068551	1.050	1.500	4.50
1	80EE2030	068552	1.315	1.875	5.75
1-1/4	80EE2530	068553	1.660	2.000	7.25
1-1/2	80EE3030	068554	1.900	2.000	8.25
2	80EE3530	068555	2.375	2.000	9.50
2-1/2	80EE4030	068556	2.750	3.000	10.50
3	80EE4530	068557	3.500	3.125	13.00
4	80EE5530	068558	4.500	3.375	16.00
5	80EE6030	068559	5.563	3.625	24.00
6	80EE6530	068560	6.625	3.750	30.00

SCEPTER PRODUCTS

CONDUIT ELBOWS - SCHEDULE 40 SPECIAL RADIUS (PLAIN END)

Size inches	Degree Bend	18" Radius Product Code	24" Radius Product Code	30" Radius Product Code	36" Radius Product Code	48" Radius Product Code	60" Radius Product Code
1	90	068702	068722	068742	068762	068782	#
	45	068802	068822	068842	068862	068882	#
	30	068902	068922	068942	068962	068982	#
	22-1/2	078853	078035	#	#	#	#
1-1/4	90	068703	068723	068743	068763	068783	#
	45	068803	068823	068843	068863	068883	#
	30	068903	068923	068943	068963	068983	#
	22-1/2	068513	078667	#	#	#	#
1-1/2	90	068704	068724	068744	068764	068784	#
	45	068804	068824	068844	068864	068884	#
	30	068904	068924	068944	068964	068984	#
	22-1/2	068523	078668	#	#	#	#
2	90	068705	068725	068745	068765	068785	068113
	45	068805	068825	068845	068865	068885	#
	30	068905	068925	068945	068965	068985	#
	22-1/2	068514	068547	#	068515	#	#
2-1/2	90	068706	068726	068746	068766	068786	#
	45	068806	068826	068846	068866	068886	#
	30	068906	068926	068946	068966	068986	#
	22-1/2	068524		#	#	#	#
3	90	068707	068727	068747	068767	068787	068114
	45	068807	068827	068847	068867	068887	#
	30	068907	068927	068947	068967	068987	#
	22-1/2	068516	068525	#	068517	068526	#
3-1/2	90		068728	068748	068768	068788	#
	45	Use Standard Schedule 40 Elbow	068828	068848	068868	068888	#
	30		068928	068948	068968	068988	#
	22-1/2		068130	#	#	#	#
4	90		068729	068749	068769	068789	068112
	45	Use Standard Schedule 40 Elbow	068829	068849	068869	068889	078011
	30		068929	068949	068969	068989	#
	22-1/2		068518	068519	068520	068521	068111
5	90			068751	068771	068791	068115
	45	Use Standard Schedule 40 Elbow		068851	068871	068891	078615
	30			068951	068971	068991	068132
	22-1/2			068529	068522	#	#
6	90				068772	068792	#
	45	Use Standard Schedule 40 Elbow			068872	068892	078220
	30				068972	068992	#
	22-1/2				068528	068527	078221
8	90	-	-	-	-	068052	#
	45	-	-	-	-	068082	#
	22-1/2	-	-	-	-	068081	#
	11-1/4	-	-	-	-	068080	#

Note: 1) # indicates available on request. Material is non-cancelable and non-returnable.
 2) Larger Radius Elbows are available on request and are non-cancelable and non-returnable.

CONDUIT ELBOWS - SCHEDULE 40 SPECIAL RADIUS (BELLED ONE END)

Size inches	Degree Bend	18" Radius Product Code	24" Radius Product Code	36" Radius Product Code	48" Radius Product Code
2	90	068014	068030	068054	068078
	45	068015	068033	068055	068079
2-1/2	90	068016	068034	068056	068086
	45	068017	068035	068057	068090
3	90	068018	068036	068058	068091
	45	068019	068037	068059	068092
3-1/2	90	Use Std. Sch. 40 Radius (15")	068038	068070	068093
	45		068039	068071	068094
4	90	Use Std. Sch. 40 Radius (16")	068050	068072	068095
	45		068053	068073	068096
5	90	Use Std. Sch. 40 Radius (24")		068074	068097
	45			068075	068098
6	90	Use Std. Sch. 40 Radius (30")		068076	068099
	45			068077	068106

CONDUIT ELBOWS - SCHEDULE 80 SPECIAL RADIUS (PLAIN END)

Size inches	Degree Bend	18" Radius Product Code	24" Radius Product Code	30" Radius Product Code	36" Radius Product Code	48" Radius Product Code
1	90	068710	#	#	#	068541
	45	#	#	#	#	#
1-1/4	90	068711	068735	#	#	068542
	45	#	#	#	#	#
1-1/2	90	068712	#	#	068545	068543
	45	#	#	#	#	#
2	90	068713	068736	#	068775	068544
	45	#	068530	#	068534	#
2-1/2	90	068714	068737	#	068776	068548
	45	#	068531	#	068535	#
3	90	068715	068738	#	068777	068794
	45	#	068532	#	068536	#
4	90	068716	068739	068549	068778	068795
	45	#	068533	#	068537	#
5	90	Use Standard Schedule 80 Radius (24")		#	068779	068796
	45			#	068538	068546
6	90				068540	068797
	45				068539	#

Note: 1) # indicates available on request. Material is non-cancelable and non-returnable.
 2) 30° and 22½° Elbows are available on request.
 3) Larger Radius Elbows are available on request and are non-cancelable and non-returnable.

CONDUIT FITTINGS



Size inches	Part Number	Product Code
Pipe Straps PVC 2 Hole		
1/2	PS10	077811
3/4	PS15	077812
1	PS20	077813
1-1/4	PS25	077814
1-1/2	PS30	077815
2	PS35	077816



Pipe straps Polyethylene (PE) 2 Hole		
2-1/2	PS40	077262
3	PS45	077263
4	PS55	077264



Pipe straps Coated Steel 2 Hole		
2	CS35	077818
2-1/2	CS40	077819
3	CS45	077820
3-1/2	CS50	077821
4	CS55	077822
5	CS60	077824
6	CS65	077823



Pipe straps Coated Steel 1 Hole		
1/2	CS10-1	077831
3/4	CS15-1	077832
1	CS20-1	077833
1-1/4	CS25-1	077834
1-1/2	CS30-1	077835
2	CS35-1	077836
3	CS45-1	077838
3-1/2	CS50-1	077839
4	CS55-1	077840

CONDUIT FITTINGS



Size inches	Part Number	Product Code
-------------	-------------	--------------

Nonmetallic Conduit Clamps & Wall Spacers

1/2	CCS10	077794
3/4	CCS15	077796
1	CCS20	077797
1-1/4	CCS25	077798
1-1/2	CCS30	077799
2	CCS35	077800
Base	CCS-B	077343

Note: CCS-B are sold individually, two pieces are required to create one base unit.

Poly Plugs



2 - 2-1/2	PP3540	077433
3 - 3-1/2	PP4550	077434
4	PP55	077435
5	PP60	077436
6	PP65	077437

Size inches	Part Number	Product Code	A inches	B inches	C inches
-------------	-------------	--------------	----------	----------	----------

Couplings

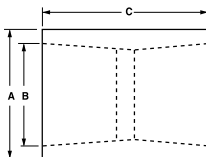

1/2	EC10	068000	1.06	0.84	1.40
3/4	EC15	068001	1.31	1.06	1.64
1	EC20	077003	1.59	1.32	2.03
1-1/4	EC25	077004	2.00	1.66	2.16
1-1/2	EC30	077005	2.23	1.90	2.28
2	EC35	077006	2.72	2.38	2.41
2-1/2	EC40	077007	3.32	2.88	3.19
3	EC45	077008	4.00	3.50	3.44
3-1/2	EC50	077009	4.50	4.00	3.63
4	EC55	077010	5.00	4.50	3.75
5	EC60	077011	6.12	5.56	4.19
6	EC65	077012	7.37	6.63	4.56
8	EC70	077866	9.30	8.66	8.25

CONDUIT FITTINGS

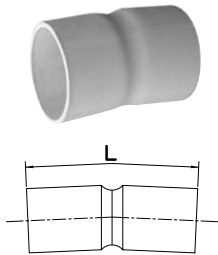

5° couplings

Size inches	Part Number	Product Code	L inches
2	5EC35	077100	4.0
2-1/2	5EC40	077101	5.5
3	5EC45	077103	6.0
3-1/2	5EC50	077102	7.0
4	5EC55	277092	7.0
5	5EC60	277093	7.5
6	5EC65	077106	11.0

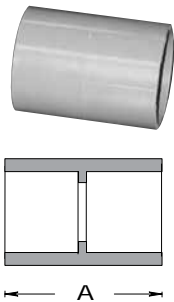

Long Line Couplings

Size inches	Part Number	Product Code	A inches
1-1/2	LLC30	077192	2.74
2	LLC35	077193	3.68
2-1/2	LLC40	077194	4.28
3	LLC45	077195	4.80
4	LLC55	077196	6.20
5	LLC60	078068	8.22
6	LLC65	077198	8.22

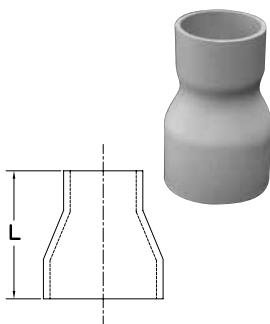

Fabricated Swedge Reducer Couplings

Size inches	Part Number	Product Code	L inches
2 x 1-1/4	SW3525	077320	4.0
3 x 2	SW4535	077321	6.0
3 x 2-1/2	SW4540	077335	6.5
4 x 2	SW5535	077322	7.0
4 x 2-1/2	SW5540	069282	-
4 x 3	SW5545	077333	7.0

CONDUIT FITTINGS

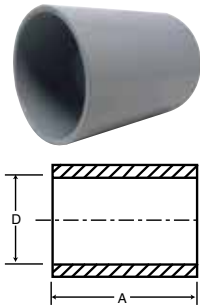

Size inches	Part Number	Product Code	A inches	D Min inches	D Max inches
-------------	-------------	--------------	----------	--------------	--------------

Repair Coupling Sleeve

1-1/2	REC30	077292	2.30	1.91	1.92
2	REC35	277293	6.50	2.37	2.40
2-1/2	REC40	077294	3.45	2.88	2.90
3	REC45	277295	6.50	3.51	3.52
4	REC55	277296	8.00	4.51	4.52
5	REC60	277297	8.00	5.58	5.60
6	REC65	277298	8.00	6.65	6.67

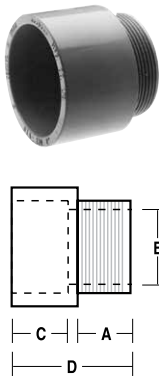

Size inches	Part Number	Product Code	A inches	B inches	C inches	D inches
-------------	-------------	--------------	----------	----------	----------	----------

Terminal Adapters - 1/2" - 1-1/4" Tapered Thread; 1-1/2" - 6" Non-Tapered Thread

1/2	TA10	077021	0.70	0.59	0.75	1.55
3/4	TA15	077022	0.68	0.79	1.00	1.75
1	TA20	077023	0.63	1.00	1.12	1.86
1-1/4	TA25	077024	0.64	1.31	1.30	2.13
1-1/2	TA30	077025	0.73	1.53	1.43	2.25
2	TA35	077026	0.80	1.97	1.15	2.10
2-1/2	TA40	077027	0.80	2.35	1.90	2.93
3	TA45	077028	0.82	2.92	2.00	3.06
3-1/2	TA50	077029	1.00	3.39	1.72	3.06
4	TA55	077030	0.82	3.85	1.99	3.22
5	TA60	077031	1.11	4.81	2.00	5.99
6	TA65	077032	1.11	5.83	2.13	6.50
8	TA80	178190	-	-	-	-

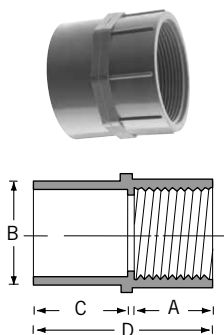

Female Adapters NPT Tapered Thread

1/2	FA10	077041	0.80	0.62	0.83	1.73
3/4	FA15	077042	0.80	0.82	1.00	1.90
1	FA20	077043	1.00	1.07	1.20	2.30
1-1/4	FA25	077044	1.02	1.40	1.30	2.43
1-1/2	FA30	077045	1.05	1.58	1.29	2.44
2	FA35	077046	1.08	2.05	1.38	2.55
2-1/2	FA40	077047	1.68	2.47	1.99	3.76
3	FA45	077048	1.63	3.09	2.15	4.10
3-1/2	FA50	077049	1.80	3.54	2.00	3.99
4	FA55	077050	1.76	4.03	2.19	4.21
5	FA60	077051	2.07	5.04	3.00	5.24
6	FA65	077052	2.07	6.05	3.00	5.24
8	FA80	178189	-	-	-	-

CONDUIT FITTINGS



Size inches	Part Number	Product Code
End Caps		
1/2	CAP10	077421
3/4	CAP15	077422
1	CAP20	077423
1-1/4	CAP25	077424
1-1/2	CAP30	077425
2	CAP35	077426
2-1/2	CAP40	077427
3	CAP45	077428
3-1/2	CAP50	277085
4	CAP55	077430
5	CAP60	077431
6	CAP65	077432



Reducer Bushings		
3/4 x 1/2	1805	077300
1 x 1/2	1805-1	077301
1 x 3/4	1806	077302
1-1/4 x 3/4	1807-1	077303
1-1/4 x 1	1807	077304
1-1/2 x 1	1808-1	077305
1-1/2 x 1-1/4	1808	077306
2 x 1	1809-1	077313
2 x 1-1/4	1809	077307
2 x 1-1/2	1810	077308
2-1/2 x 2	1811	077309
3 x 2	1812-1	077310
3 x 2-1/2	1812	077311
4 x 2	1813-1	077319
4 x 3	1813	077312
4 x 3-1/2	1814	077317



Threaded Reducer Bushings		
3/4 x 1/2	1825	077314
1 x 1/2	1826	077315
1 x 3/4	1827	077316

CONDUIT FITTINGS



Size inches	Part Number	Product Code
End Bells		
1/2	EB10	077406
3/4	EB15	077085
1	EB20	077323
1-1/4	EB25	077324
1-1/2	EB30	077325
2	EB35	077326
2-1/2	EB40	077327
3	EB45	077328
3-1/2	EB50	077329
4	EB55	077330
5	EB60	077331
6	EB65	077332
8*	EB80	277094
8**	FEB80	077652

* NEW Molded, ** Fabricated



Size inches	Part Number	Product Code	A (inches) max.	B (inches) min.	Travel inches
TA Special Expansion Joint					
2-1/2	EJ40TA	077398	30.33	18.33	12

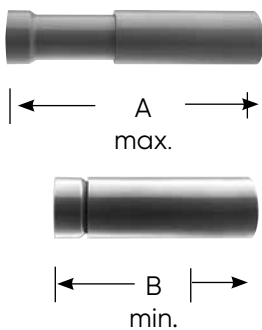

Size inches	Part Number	Product Code	A (inches) max.	B (inches) min.	Travel inches
"O" Ring Expansion Joints					
1/2	EJ10	277156	12.00	8.00	4
3/4	EJ15	077382	12.00	8.00	4
1	EJ20	077383	12.50	8.50	4
1-1/4	EJ25	077384	13.00	9.00	4
1-1/2	EJ30	077385	13.00	9.00	4
2	EJ35	077386	13.25	9.25	4
2-1/2	EJ40	077387	22.25	14.25	4
3	EJ45	077388	22.25	14.25	8
3-1/2	EJ50	077389	22.25	14.25	8
4	EJ55	077390	22.25	14.25	8
5	EJ60	077391	22.25	14.25	8
6	EJ65	077392	22.25	14.25	8

SCEPTER PRODUCTS

CONDUIT FITTINGS

Dimension (in)	Part Number	Product Code	A Diameter	2 Length	3 Length	Overall Length
----------------	-------------	--------------	------------	----------	----------	----------------

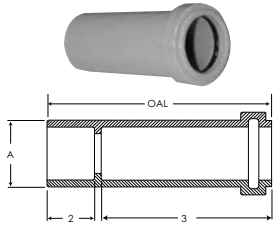

One-Piece Expansion Coupling

1/2	OPEJ10	077018	1.10	0.66	2.47	3.25
3/4	OPEJ15	077019	1.31	0.73	2.65	3.50
1	OPEJ20	077053	1.61	0.89	2.73	3.75
1-1/4	OPEJ25	077054	1.99	0.95	2.90	4.00
1-1/2	OPEJ30	077061	2.21	1.08	3.03	4.25
2	OPEJ35	077063	2.70	1.14	3.21	4.50

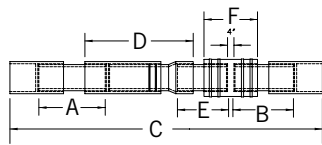

Size inches	Part Number	Product Code	A Ref	B Ref	C Ref	D Ref	E Ref	F Ref
-------------	-------------	--------------	-------	-------	-------	-------	-------	-------

Expansion & Deflection Fitting Assemblies*

2	SE-J-35	077889	9.88	7.38	35.0	9.25	4.25	9.75
3	SE-J-45	077890	9.88	7.25	40.5	14.50	5.00	10.00
4	SE-J-55	077891	8.13	7.00	39.0	15.00	5.50	10.00

complete assembly, *Not Certified

Size inches	Part Number	Product Code
-------------	-------------	--------------

Nonmetallic Threaded Strain Relief Connectors c/w "O"Ring, Locknut & 4 Grommets

1/2	TSRCU10	077244
3/4	TSRCU15	077261

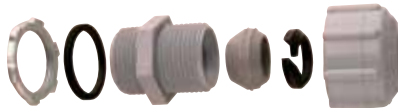

Strain Relief Connectors c/w Grommets

3/4	SRCU15 c/w 4 grommets	077209
-----	-----------------------------	--------



From inches	To inches
-------------	-----------

Strain Relief Connectors Grommet Dimensions

	Ø = .240	Ø = .300"
	Ø = .290	Ø = .385
	Ø = .405	Ø = .500
	Ø = .525	Ø = .625

CONDUIT FITTINGS



Hub Size inches	Part Number	Product Code
-----------------	-------------	--------------

"Two In One" Pull Elbow

The "two in one" access pull elbow reduces inventory costs (3/4" hub fitting supplied with 3/4" x 1/2" reducers). This pull elbow is approved for wet locations and provides for easy wire pulling.

"Two In One" Pull Elbow

1/2 or 3/4	PE15/10	077491
------------	---------	--------



Service Entrance Fittings

1/2	EF10	077281
3/4	EF15	077282
1	EF20	077283
1-1/4	EF25	077284
1-1/2	EF30	077285
2	EF35	077286
2-1/2	EF40	077287
3	EF45	077288
3-1/2	EF50	077289
4	EF55	077290



Schedule 40 Slip Meter Risers (c/w TA fitting)

1-1/4	SMR12TA	068107
1-1/2	SMR15TA	068108
2	SMR20TA	068063
2-1/2	SMR25TA	068064
3	SMR30TA	068373
4	SMR40TA	068065

Slip Meter Risers allow the underground PVC service conduit to 'slip' inside the fitting and thus account for ground movement. The factory assembled SMR fitting is supplied with a male adapter, is 2 feet in length and is sized to accept the underground raceway (i.e. 2" underground service conduit requires a 2" SMR). The SMR fitting must be installed with the open barrel end towards the ground.

CONDUIT FITTINGS



Size inches	Part Number	Product Code
-------------	-------------	--------------

Meter Offsets

1-1/4	MO25	077941
2	MO35	077942

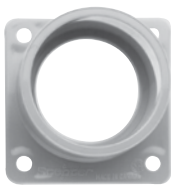

Meter Hubs

1-1/4	MHU25	077961
1-1/2	MHU30	077963
2	MHU35	077965
2-1/2	MHU40	077967
3	MHU45	077968



Size inches	Part Number	Product Code	A inches	B inches
-------------	-------------	--------------	----------	----------

Long Meter Offsets Fabricated

1-1/4	LMO25	069641	12	0.91
1-1/2	LMO30	069645	12	1.61
2	LMO35	069646	14	1.50



For electricians, power utilities, telecom service providers and infrastructure contractors who work on the toughest construction projects in the market. IPEX provides the most comprehensive range of quality products and superior service, that meet or exceed all industry standards.

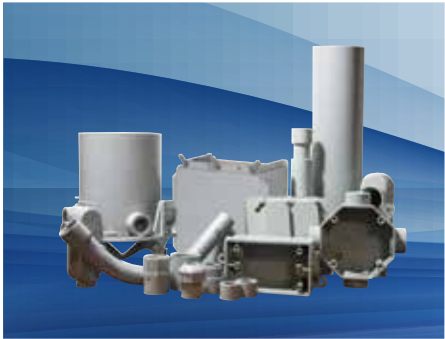

Scepter® Rigid Pipe and Fittings

- Smooth interior surface reduces friction during wire pull
- Extensive product offering including boxes, fittings, couplings & elbows
- High impact & tensile strength

Sceptalight™ LED Hazardous Locations

- CSA certified for hazardous locations
- CLASS I, DIV 2 Groups A, B, C & D
- CLASS II DIV 2 Groups F & G
- Suitable for industrial environments with flammable or explosive gases, vapours or dusts

Kwikon® ENT and Fittings

- Easy installation saves time and money
- Complete concrete-tight system
- FT-4 rated
- Strong and flexible ENT tubing
- Six locking tabs for fast connections

SCEPTER PRODUCTS

ACCESS FITTINGS

No other manufacturer offers such an extensive range of access fitting sizes (1/2" to 4") or hub configurations (LL, T, TB, LB, E, C, LR). CSA certified and UL listed, Scepter access fittings come fully factory assembled so parts cannot be misplaced during shipping and handling.

Manufactured with threaded brass screws and inserts, and flexible PVC gaskets, Scepter access covers can be removed as often as needed without wear or cracking.

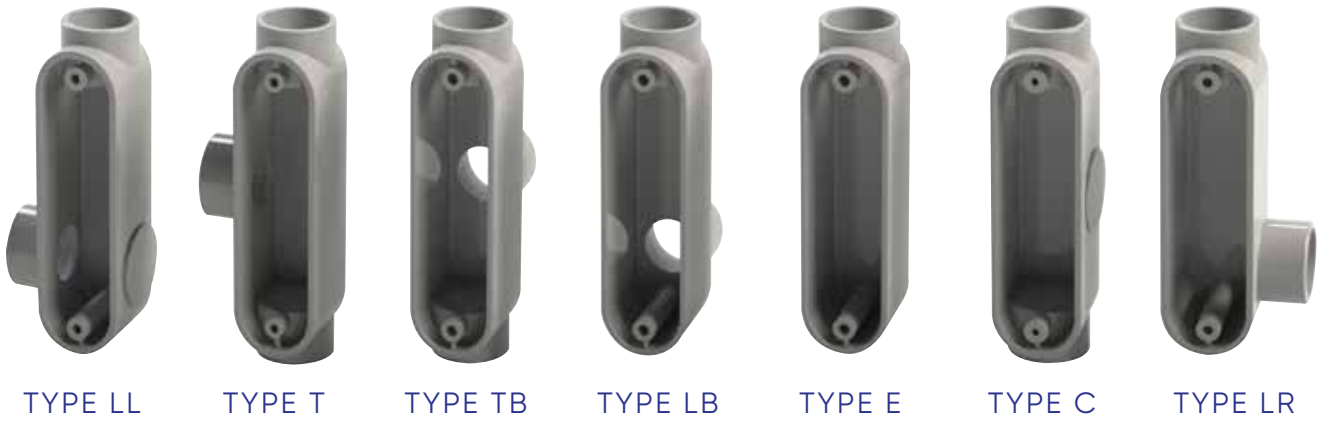

Access Fitting Dimensions

Size inches	A	B	C	D	E	F	G	H	I	J	K	L
	inches											
1/2	5.6	0.6	1.3	1.1	0.8	4.3	4.1	1.3	2.5	2.3	1.0	0.8
3/4	5.6	0.8	1.5	1.3	1.1	5.4	4.1	1.3	2.5	2.8	1.0	0.8
1	6.5	0.9	1.7	1.6	1.3	6.3	4.8	1.5	2.1	3.3	1.1	1.1
1-1/4	7.9	1.1	2.3	2.0	1.7	7.6	5.8	1.8	3.6	4.0	1.6	1.0
1-1/2	8.5	1.1	2.7	2.3	1.9	8.3	6.5	1.8	3.9	4.3	1.7	1.1
2	10.9	1.2	3.2	2.8	2.4	10.5	8.2	2.3	4.5	5.4	2.0	1.2
2-1/2	14.6	1.8	4.5	4.0	2.9	13.6	9.8	3.8	6.2	7.3	2.6	-
3	14.6	1.9	4.5	4.0	3.5	13.6	10.9	2.7	6.2	7.3	2.6	-
3-1/2	17.0	2.1	5.5	5.0	4.0	16.0	11.5	4.5	7.5	8.5	3.0	-
4	17.0	2.1	5.5	5.0	4.5	16.0	11.5	4.5	7.5	8.5	3.0	-

Hub Size inches	Part Number	Product Code
-----------------	-------------	--------------

Access Fittings Type LL

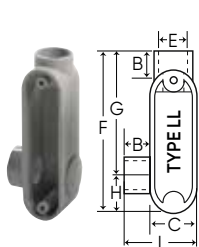

1/2	SLL10S	077521
3/4	SLL20S	077522
1	SLL30S	077523
1-1/4	SLL40S	077524
1-1/2	SLL50S	077525
2	SLL60S	077526
2-1/2	SLL70S	077527
3	SLL80S	077528
3-1/2	SLL90S	077530
4	SLL100S	077529

Access Fittings Type T

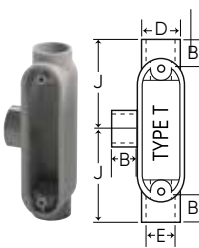

1/2	ST10S	077461
3/4	ST20S	077462
1	ST30S	077463
1-1/4	ST40S	077464
1-1/2	ST50S	077465
2	ST60S	077466
2-1/2	ST70S	077467
3	ST80S	077468
3-1/2	ST90S	077571
4	ST100S	077572

Access Fittings Type TB

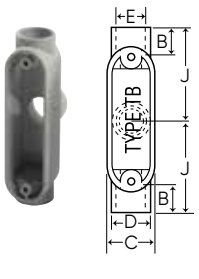

1/2	STB10S	077451
3/4	STB20S	077452
1	STB30S	077453
1-1/4	STB40S	077454
1-1/2	STB50S	077455
2	STB60S	077456

Access Fittings Type LB



1/2	SLB10S	077541
3/4	SLB20S	077542
1	SLB30S	077543
1-1/4	SLB40S	077544
1-1/2	SLB50S	077545
2	SLB60S	077546
2-1/2	SLB70S	077547
3	SLB80S	077548
3-1/2	SLB90S	077549
4	SLB100S	077550

Hub Size inches	Part Number	Product Code
-----------------	-------------	--------------

Access Fittings Type E

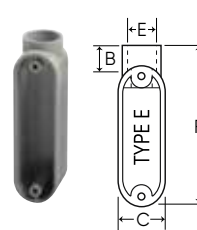

1/2	SE10S	077561
3/4	SE20S	077562
1	SE30S	077563
1-1/4	SE40S	077564
1-1/2	SE50S	077565
2	SE60S	077566
2-1/2	SE70S	077567

Access Fittings Type C

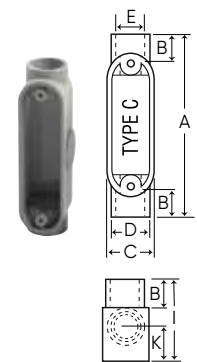

1/2	SC10S	077501
3/4	SC20S	077502
1	SC30S	077503
1-1/4	SC40S	077504
1-1/2	SC50S	077505
2	SC60S	077506
2-1/2	SC70S	077507
3	SC80S	077508
3-1/2	SC90S	077510
4	SC100S	077509

Access Fittings Type LR

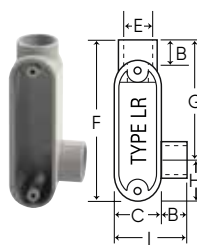

1/2	SLR10S	077481
3/4	SLR20S	077482
1	SLR30S	077483
1-1/4	SLR40S	077484
1-1/2	SLR50S	077485
2	SLR60S	077486
2-1/2	SLR70S	077480
3	SLR80S	077488
3-1/2	SLR90S	077487
4	SLR100S	077489

All access fittings are CSA certified and UL listed for wet locations.

Access Fittings are supplied with threaded brass inserts, combination brass head screws and PVC gasket and cover.

SCEPTER PRODUCTS

BOXES - F SERIES

Our complete range of Scepter boxes and covers makes it easy to locate power and control precisely where you want it.

Scepter F-Series 3-in-1 PVC surface mount outlet boxes are available in single (deep), double and triple-gang configurations, with 1/2", 3/4" and 1" entry hubs all in one box. This innovative design enables contractors to reduce inventory, while ensuring they have the size they need when they need it.

With the exception of the FD, FD2 & FD3 Blank Boxes, Scepter F Series Boxes are molded with 1" conduit hubs and supplied with reducer bushings. The conduit hub(s) are field modified as 1/2", 3/4" or 1" to accommodate job-site requirements. The appropriate quantity of 1" x 3/4" and 3/4" x 1/2" reducers to create the desired hub size are packaged with each FD Series Single Gang Deep, Double Gang and Triple Gang Box.

All F Series boxes are supplied with integral mounting feet, threaded brass inserts and grounding screw.

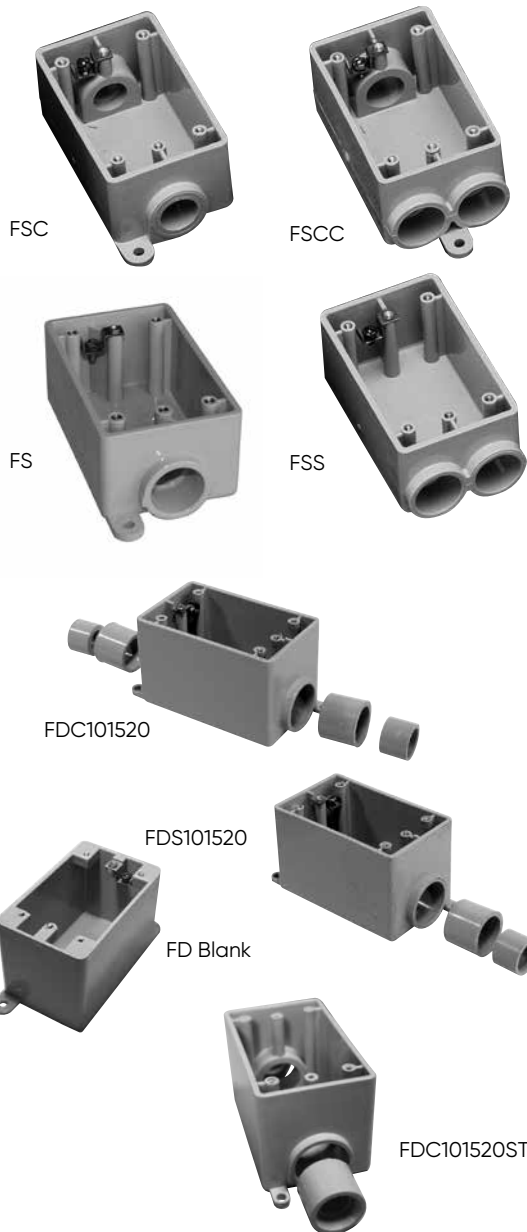

Hub Size inches	Part Number	Product Code	Volume in ³
Single Gang Boxes			
1/2	FSC10	077607	17.0
3/4	FSC15	077608	17.0
1/2	FS10	077601	17.5
3/4	FS15	077602	17.5
1/2	FSCC10	077622	16.3
3/4	FSCC15	077623	16.3
1/2	FSS10	077604	17.0
3/4	FSS15	077605	17.0

Note: 10 = 1/2" Hub, 15 = 3/4" Hub
Outside Dimensions: Length, 4-9/16" - Width, 2-13/16" - Depth, 2"

Single Gang Deep Boxes			
1/2, 3/4, 1	FDC101520	077291	26.0
1/2, 3/4, 1	FDS101520	077299	26.8
*BLANK	FD BLANK	077603	29.2
347 VOLT	FD347	077610	29.2

Note: 10 = 1/2" Hub, 15 = 3/4" Hub, 20 = 1" Hub
Outside Dimensions: Height, 4 9/16" - Width, 2 13/16" - Depth 2 3/4",
Cubic Inches = 35.30

* Not UL Listed

F-Series Single Gang Deep Boxes for use with Self-taping, stainless steel screws

1/2, 3/4, 1	FDS 101520ST	077847	26.8
1/2, 3/4, 1	FDC 101520ST	077849	26.0

Screws are not included

BOXES - F SERIES

Hub Size inches	Part Number	Product Code	OD (inches)			Volume (in ³)
			H	W	E	
Double Gang boxes						
1/2, 3/4, 1	FS-2-101520-U	077364	4.62	4.62	2.5	38.5
1/2, 3/4, 1	FSC-2-101520-U	077368	4.62	4.62	2.5	37.0
1/2, 3/4, 1	FSS-2-101520-U	077372	4.62	4.62	2.5	37.0
1/2, 3/4, 1	FSCC-2-101520-U	077369	4.62	4.62	2.5	35.0
*Blank	FD-2-U	077649	4.75	4.75	3.0	47.5

* Not UL Listed

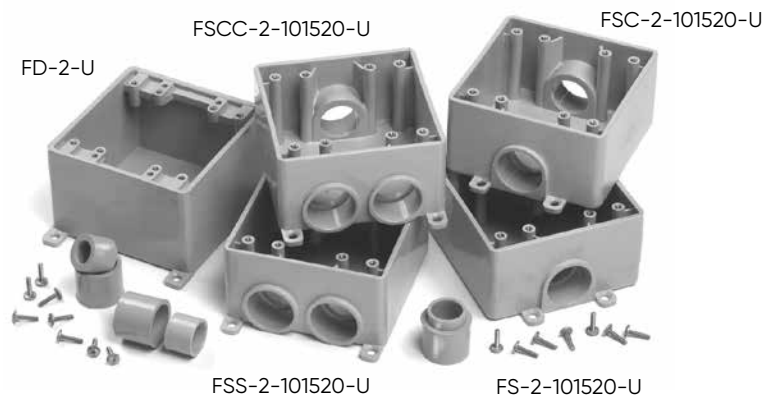
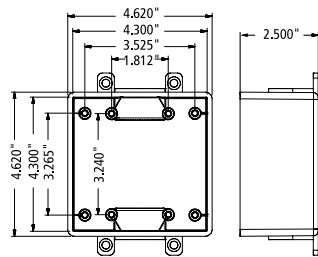

Hub Size inches	Part Number	Product Code	OD (inches)			Volume (in ³)
			H	W	E	
Triple Gang Boxes						
1/2, 3/4, 1	FS-3-101520	077337	4.5	6.6	2.5	56.0
1/2, 3/4, 1	FSC-3-101520	077438	4.5	6.6	2.5	54.0
*Blank	FD-3	077737	4.5	6.6	3.0	73.8

* Not UL Listed

Octagonal Boxes are shipped complete with cover, gasket, 4 reducing bushings (3/4" x 1/2"), and 4 sealing caps to be installed from inside box to seal off unused entry hubs.



Size inches	Part Number	Hub Size inches	Product Code
Octagonal Boxes*			
4 x 1-1/2	OB15/10	1/2 - 3/4	077983*
4 x 2-1/8	OB20	1	077984*



Size inches	Part Number	Product Code
Octagonal Box Extension Rings		
4 x 1 deep	XR20	077989
4 x 2 deep	XR35	077990

Note: Octagonal Boxes are not designed for supporting light fixtures.

SCEPTER PRODUCTS

COVER PLATES - F SERIES

Description	Part Number	Product Code
Single Gang Plates		
Duplex Receptacle	DRC15/10	077617
Toggle Switch	TSC15/10	077616
Single Receptacle	20RC15/10	077618
Single Receptacle	20-3RC15/10	077619
Single Receptacle	30-3RC15/10	077620
Blank c/w Gasket	BRC15/10	077611
PVC Gasket	GASK15/10	077621

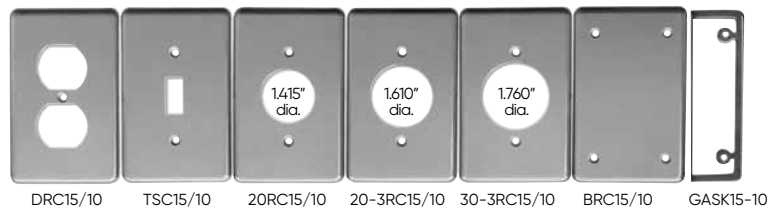

Double Gang Plates

Blank Cover c/w Gasket	BRC20-2-U	077359
Double Switch	TSC20-2-U	077373
Double Duplex Receptacle	DRC20-2-U	077362
Combo Switch Duplex Receptacle	TSDC20-2-U	077374
PVC Gasket	GASKFU20-2	172650

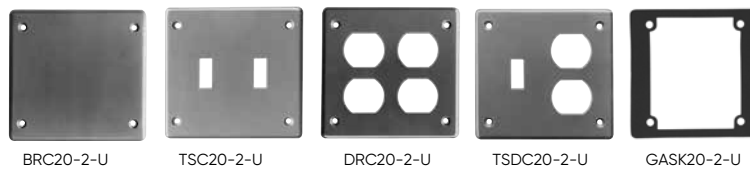

Triple Gang Plates

Triple Receptacle	DRC20-3	077747
Combo Switch Receptacle	DSDR20-3	077745
Triple Switch	TSC20-3	077744
Combo Switch Receptacle	TSDC20-3	077746
Blank Cover c/w Gasket	BRC20-3	077748
PVC Gasket	GASK20-3	077749



WEATHERPROOF COVERS

Manufactured with stainless steel return-springs/clips and packaged with brass screws, Scepter weatherproof covers provide a positive seal, even in cold temperatures.



VPT15/10



VSC15/10



WTG15/10



WDR15/10
RWDRE15/10



WGF15/10
RWGF15/10



WTL15, WTL20,
WTL30



WTL50



WDRE15/10
RWDRE15/10



VSCU20-2



VSDRU20-2



VSRC20-2



VSGG20-2



VSDD20-2

Single Gang Weatherproof Covers

Description	Device Opening (in)	Part Number	Product Code
Plunger-style Switch Cover		VPT15/10	077630
Toggle Switch Cover		VSC15/10	077612
Grey Toggle Switch Cover		WTG15/10	077606
Grey Duplex Receptacle		WDR15/10	077993
White Duplex Receptacle		RWDRE15/10	077786
Grey Ground Fault Receptacle		WGF15/10	077785
White Ground Fault Receptacle		RWGF15/10	077787
Single Receptacle Device 15 AMP	1.375	WTL15	077992
Single Receptacle Device 20 AMP	1.625	WTL20	077994
Single Receptacle Device 30 AMP	1.722	WTL30	077991
Single Receptacle Device 50 AMP	2.187	WTL50	077951
Grey Double Door Duplex Receptacle		WDRE15/10	077087
White Double Door Duplex Receptacle		RWDRE15/10	077408
Gasket for W Series Cover (except WDRE & RWDRE)		GASKW	077755
Gasket for WDRE & RWDRE Covers		GASKDD	072225

Gaskets are included with all weatherproof covers.

Double Gang Weatherproof Covers

Toggle Switch Cover		VSCU20-2	077376
Combination Switch Cover & GFI Receptacle		VSRC20-2	077357
Combination Switch Cover & Duplex Receptacle		VSDRU20-2	077356
Double Door GFCI Cover		VSGG20-2	077096
Double Door Duplex Cover		VSDD20-2	077097
Gasket for Double Gang (except VSGG20-2 & VSDD20-2)		GASKFU20-2	172650
Gasket for VSGG20-2 and VSDD20-2 Double Gangs		GASKV20-2	072227

Gaskets are included with all weatherproof covers. VSGG20-2 and VSDD20-2 are universal and will fit on most PVC and metal boxes.

SCEPTER PRODUCTS

SCEPTER PVC ROUND FLOOR BOX

Suitable for slab-on-grade, below grade and wood floor construction, Scepter PVC round floor boxes and accessories enable contractors to collectively run in-floor power, data and communications wiring to a single box for significant savings in time and materials.

Installation is quick and simple, with our nonmetallic floor box and covers, saving both time and money over similar metallic assemblies.

Scepter's floor box and duplex receptacle covers are constructed from high impact, noncorroding and nonconducting PVC. The flush-mount covers are available in custom colors and are shipped with a levelling ring complete with a grounding clip. Metal cover adapter kits are also available, allowing you to adapt to metal floor plates. Our 6" deep floor box allows flexibility for various concrete floor pours, while our 4-3/4" width offers easy access and ample wire room. The box comes complete with two 1" and two 3/4" hub openings. All boxes are shipped complete with reducer plugs for added versatility.

Complete technical information available at www.ipexna.com – Nonmetallic Floor Box & Accessories Technical Manual.

	Color Description	Part Number	Product Code	
 FB	Floor Box Base (includes disposable protective cap and reducer plugs)	FB	076954	
 FBS-KIT	Floor Box Base c/w Leveling Ring Adapter (includes disposable protective cap, reducer plugs and leveling ring adapter)	FBKIT	077068	
 FBS-KIT	Floor Box Stand Kit (includes FB Box) (is equipped with several height brackets which accommodate the different rebar and post-tension cable heights and slab depths found from job-site to job-site.)	FBS-KIT	077700	
 AFMC	Metal Cover Adapter Kit (includes levelling ring, metal cover adapter and 2 gaskets)	AFMC	076953	
 LRA-U	Universal Leveling Ring Adapter	LRA-U	076606	
 FBDRC	Floor Box Duplex Receptacle Cover (Nonmetallic) (includes flush mount cover, blank cover & gasket)	Brown Gold Grey Light Almond	FBDRCB FBDRCG FBDRCGr FBDRCA	076955 076949 076600 076605
 FBUDK	Tri-Service Universal Divider Kit (includes upper and lower dividers, riser tube and 2 grommets)	FBUDK	077948	
 FBYC	Y Connector (3/4")	FBYC	077499	

BRASS AND NICKEL COVER PLATES

These cover plates help to protect enclosed power data and communications wiring from daily environmental floor conditions such as mopping (UL scrub water tested) and foot traffic (UL approved for cover loading).

The covers feature a light lacquer finish for extra strength and durability in high traffic areas and include a rubber gasket and aluminum backing plate to create a water-tight seal. The flush mount cover plates should be installed to the floor box using the LRA-U.



DFL-2-N

Nickel Cover Plates

Duplex Receptacle Cover with Dual Flip Lid

DFL-2-N

178279



SSC-N

Duplex Receptacle Cover with Individual Screw Plug Openings

SSC-N

178278



DSC-N

Combination 2" x 1/2" Single Screw Plug Opening

DSC-N

178280

Brass Cover Plates



DFL-2

Duplex Receptacle Cover with Dual Flip Lid

DFL-2

178096



SSC

Duplex Receptacle Cover with Individual Screw Plug Openings

SSC

178093



DSC-N

Combination 2" x 1/2" Single Screw Plug Opening

DSC

178091

Combination 2" x 1/2" Single Screw Plug and 1/2" Datacomm Opening

DSC-P/C

178092

SCEPTER PRODUCTS

JUNCTION BOXES

NEMA rated 1, 2, 3, 4, 4X, 6P, 12, 13 and UL approved for use in wet locations, Scepter's JB PVC molded **JUNCTION BOXES** are available in sizes from 4" x 4" x 2" to 12" x 12" x 8" and supplied with threaded brass screws and inserts, flexible PVC gaskets and external mounting feet. Nylon or stainless steel screws, as well as larger sizes are available on request.

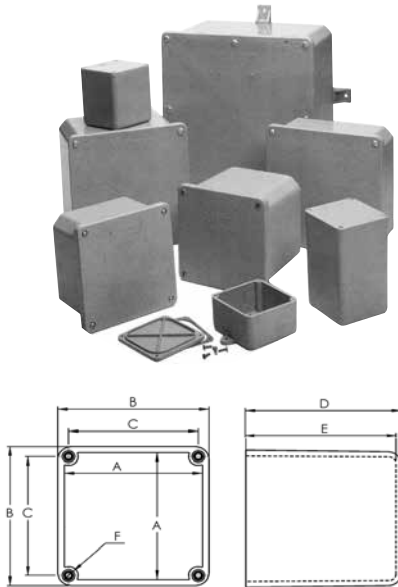

Part Number	Product Code	A inches	B inches	C inches	D inches	E inches	F inches
-------------	--------------	----------	----------	----------	----------	----------	----------

PVC Molded Junction Boxes

JB442	077659	3.71	4.05	3.42	2.15	1.99	8-32
JB444	077696	3.65	4.00	3.43	4.17	4.02	8-32
JB446	077669	3.65	4.02	3.43	6.23	6.00	8-32
JB552	077670	4.66	5.00	4.50	2.00	1.85	8-32
JB664	077697	6.08	6.41	5.80	4.20	4.00	8-32
JB666	077698	6.02	6.38	5.80	6.00	6.21	8-32
JB884	077664	8.06	8.60	7.95	4.18	3.97	1/4-20
JB887	077671	8.10	8.60	7.95	7.24	7.00	1/4-20
JB12124	077672	11.93	12.48	11.84	4.26	4.00	1/4-20
JB12126	077666	11.97	12.36	11.80	6.25	5.99	1/4-20
JB12128	077668	11.90	12.50	11.84	8.24	7.96	1/4-20

Scepter PVC Junction Boxes are:
NEMA 1, 2, 3, 4, 4X, 6P, 12, 13, UL listed for wet locations

Fabricated Boxes

Unflanged PVC fabricated boxes of any size may be made to customers' specifications and come complete with lids, gaskets and screws. These boxes are not UL Certified and are not returnable.



Description	Part Number	Product Code
-------------	-------------	--------------

Threaded Junction Boxes

	LFB150C	077250
	LFB150T *	077251

*LFB150T complete with 1/2 threaded" hole in center of cover

JUNCTION BOXES

Scepter's **JB FLANGED 'H' SERIES JUNCTION BOXES** feature a fiber-reinforced safety tread cover which uses a recessed Hex Key fastening hardware for a simple installation while reducing the opportunity for tampering. These boxes are not UL Certified and are not returnable.

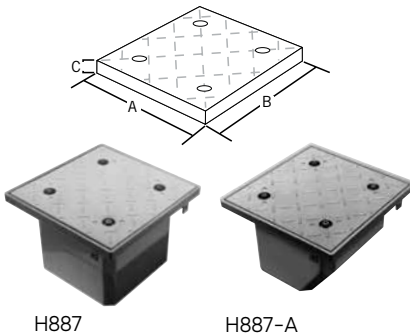

Part Number	Product Code	Box ID (inches)			Lid Dimensions (inches)			Volume (in ³)
		L	W	D	A	B	C	
Flanged Box w Fire-reinforced Safety Tread Cover								
H664	077685	6	6	4-1/4	9.0	9.0	0.60	138.0
H666	077686	6	6	6-1/4	9.0	9.0	0.60	211.0
H884	077687	8	8	4-1/4	11.5	11.5	0.75	248.0
H886	077688	8	8	6-1/4	11.5	11.5	0.75	434.0
H887	077689	8	8	7-1/4	11.5	11.5	0.75	434.0
H887-A	077692	8	8	7-1/4	11.5	11.5	0.75	434.0

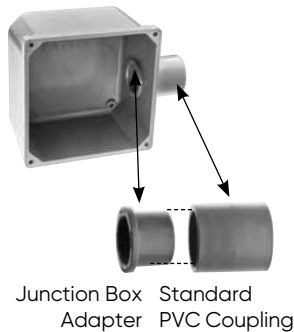
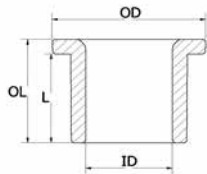

Size (inches)	Part Number	Product Code	ID	OD (inches)	L	OL
Junction Box Adapters						
1/2	JBA05	077721	0.62	1.20	0.81	0.95
3/4	JBA07	077722	0.79	1.40	0.87	1.01
1	JBA10	077723	1.00	1.58	0.89	1.06
1-1/4	JBA12	077724	1.35	1.98	1.12	1.30
1-1/2	JBA15	077725	1.59	2.37	1.10	1.33
2	JBA20	077726	2.05	2.85	1.25	1.54
2-1/2	JBA25	077727	2.45	3.34	1.68	1.99
3	JBA30	077728	3.05	3.10	1.77	2.11
3-1/2	JBA35	077729	3.54	4.50	2.09	2.41
4	JBA40	077730	4.02	5.03	1.99	2.30

SCEPTER PRODUCTS

VERTICAL-LOK SPACERS

Size (inches)	Part Number	Product Code	Dimensions (inches)					
			C	D	E	F	G	H
Intermediate Vertical-Lok Spacers								
2 x 1-1/2	IS3530	029550	1.52	1.50	3.95	3.95	3.94	0.63
2 x 2	IS3535	029551	2.03	2.06	4.48	4.48	4.47	0.63
2 x 3	IS3545	029552	3.00	3.03	5.45	5.45	5.44	0.63
3 x 1-1/2	IS4530	029582	1.50	1.45	5.15	5.12	5.12	0.88
3 x 2	IS4535	029554	2.00	1.88	5.64	5.63	5.63	0.88
3 x 3	IS4545	029555	3.00	2.88	6.66	6.63	6.63	0.88
4 x 1	IS5520	029583	1.00	1.03	5.66	5.63	5.63	0.88
4 x 1-1/2	IS5530	029557	1.50	1.39	6.13	6.14	6.13	0.88
4 x 2	IS5535	029558	2.00	1.88	6.64	6.63	6.63	0.88
4 x 3	IS5545	029559	3.00	2.90	7.64	7.64	7.63	0.88
5 x 1-1/2	IS6030	029584	1.68	1.69	7.37	7.37	7.37	0.88
5 x 2	IS6035	029561	2.25	2.15	7.89	7.89	7.88	0.88
5 x 3	IS6045	029562	3.06	2.96	8.70	8.70	8.69	0.88
6 x 1-1/2	IS6530	029563	1.50	1.38	8.24	8.22	8.21	0.88
6 x 2	IS6535	029564	2.00	1.89	8.74	8.73	8.72	0.88
6 x 3	IS6545	029565	3.00	2.90	9.77	9.77	9.75	0.88
* 8 x 2	IS8035	029294	2.06	2.00	10.58	10.80	10.80	*

* Do not have rebar slots

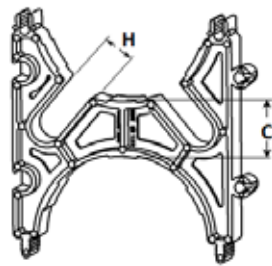
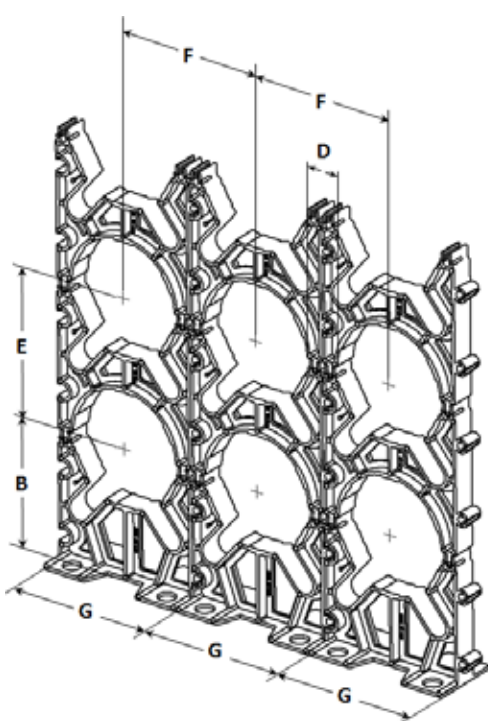

Part Number	Product Code	Dimensions (inches)			
		A	B	H	G
Base Vertical-Lok Spacers					
BS3530	029566	3.04	4.25	0.63	3.94
BS3535	029567	3.04	4.25	0.63	4.47
BS3545	029568	3.04	4.25	0.63	5.44
BS4530	029585	3.00	5.84	0.88	5.12
BS4535	029570	2.97	4.78	0.88	5.63
BS4545	029571	3.00	4.81	0.88	6.63
BS5520	029586	3.00	5.32	0.88	5.63
BS5530	029573	3.00	5.31	0.88	6.13
BS5535	029574	3.06	5.38	0.88	6.63
BS5545	029575	3.06	5.38	0.88	7.63
BS6030	029587	3.00	5.84	0.88	7.37
BS6035	029577	3.13	5.94	0.88	7.88
BS6045	029578	3.19	6.00	0.88	8.69
BS6530	029579	3.02	6.38	0.88	8.21
BS6535	029580	3.02	6.38	0.88	8.72
BS6545	029581	3.00	6.38	0.88	9.75
* BS8035	029293	3.00	7.25	*	10.80

* Do not have rebar slots

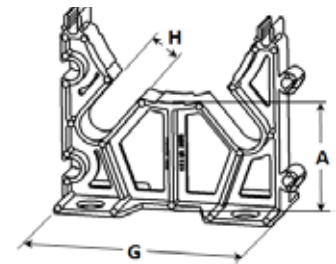

RECOMMENDED DISTANCE: 6' - 7'

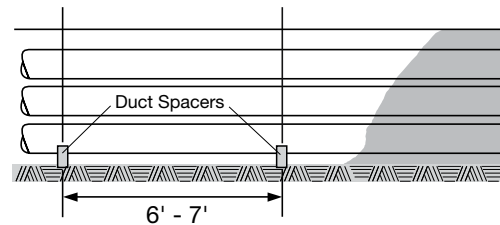

* Do not have rebar slots

CEMENTS AND PRIMERS

- PVC cements and primers include applicator cap unless otherwise noted
- Low VOC Solvent Cement is LEED (Leadership in Energy and Environmental Design) compliant
- PVC is recyclable and can be reground into new product
- VOC emissions are less than 510 grams per litre for PVC Solvent Cement
- UL GREENGUARD Gold certified

Size	Part Number	Product Code
------	-------------	--------------

IPEX 100 PVC Conduit Solvent Cement



1/2 Pint	CEMC05	078883
Pint	CEMC10	078884
Quart	CEMC20	078885
*Gallon	CEMC80	078887

*applicator not included

PVC Cold Weather / Wet Weather Cement



Pint	CWC10	078503
Quart	CWC20	078886

IPEX 100T Primer – Clear



Pint	-	078174
Quart	-	078175

IPEX Primer – Purple

Quart	PRMP20	078054
-------	--------	--------

IPEX Grey PVC Medium Bodied Cement

Pint	CEMG10	078083
Quart	CEMG20	078096

AVERAGE # OF JOINTS PER PINT OR QUART OF CEMENT

Nominal Pipe Size inches	# of Joints per Pint	# of Joints per Quart
1/2	350	700
3/4	200	400
1	150	300
1-1/4	110	220
1-1/2	80	160
2	45	90
2-1/2	40	80
3	35	70
3-1/2	30	60
4	24	48
5	10	20
6	8	16

SCEPTER JBOX

The EASIEST Junction Box you'll EVER use

The frustrations are gone – no more worries about positioning a gasket or over-tightening a cover screw, and no more loose parts to misplace before installation. We've added features to make the installation of a junction box faster and easier; whether locating and aligning conduit entry holes, easily mounting the box to a wall or pole or installing a cover with only one hand, you will appreciate the new design features.

The original junction box is completely redesigned and new features have been added to make the Scepter® JBox™, the Next Generation Junction Box the easiest box to use. The patent pending integral gasket, non-metallic fasteners, molded mounting feet, embossed grid-lines and flat cover features have been engineered to provide a contractor-friendly junction box.

The Scepter JBox is ideally suited for indoor and outdoor use and made to perform in the most demanding environments. Made of PVC it is extremely durable and resistant to impact in a wide range of temperatures and not adversely affected by water and chemicals. Built for corrosive environments, the Scepter JBox is entirely non-metallic, eliminating corrosion concerns with screws and other metal parts.

APPLICATIONS

- CORROSIVE ENVIRONMENTS
- MARINE & CAR WASHES
- WASH DOWN
- AGRICULTURAL
- WASTE-WATER TREATMENT FACILITIES



ADVANTAGES

ZERO FOOTPRINT

Design allows for installation in corners and immediately adjacent to other products. There is easy access to all mounting feet and fasteners.

INSTALLING OVERHEAD

Integral fasteners allow for easy overhead positioning and securing.

MOUNTING IN A COVER

Pilot lights, control switches and other devices are easily mounted. The Cover is free and clear of supporting ribs, and has a uniform thickness.

ADDED SECURITY

Sizes 6" and larger feature a lock-out option. Tie-wrap, tamper resistant bolt or padlock will restrict access to the box.

MORE INTERIOR VOLUME

Increased space from wire pulling and for ease of bend radius. The increased cubic inch volume allows for more flexibility



SCEPTER JBOX

FEATURES & BENEFITS

FASTENERS

- Close by hand – tool assist to open
- 100% non-metallic – corrosion resistant material
- No loose hardware for easy installation



LOCK-OUT OPTION

- Available on sizes 6" to 16"
- Use a tie-wrap, bolt or padlock for added security



INTEGRATED GASKET

- Injection molded gasket permanently fixed to the cover –no installation required
- Proprietary gasket material creates a 6P rated enclosure FLAT COVER
- No ribs – offers a flat, smooth surface for mounting of devices or labels
- No engravings



BACK PANEL

- Designed to fit sizes 6" and 16"
- Made of 14 gauge carbon steel
- White epoxy powder-coated finish
- Easy to cut and drill to mount devices



GRIDLINES

- Easy reference for drilling knockouts
- Makes conduit alignment a snap
- Indicates a "drill zone"



MOUNTING FEET

- Molded –no loose parts to assemble
- Located on corners out of the way of conduit connections
- Flush with the back of the box for close surface mounting
- Integrated design of mounting feet offers improved strength



POLE MOUNTING KIT

- One kit fits 4" to 16"
- Supplied as a complete kit
- Works with wood, concrete, steel and composite poles
- Installs on round, square & octagonal poles up to 15" diameter



PERFORMANCE RATINGS

MAXIMUM TEMPERATURE RANGE: Maximum ambient temperatures to 122°F (50°C) as per the NEC

RECOMMENDED OPERATING TEMPERATURE: -40°F to 122°F (-40°C to 50°C)

UV AND WATER EXPOSURE RATING: UL 746C approved for exposure to UV and water

FLAME & SMOKE RATING: UL 94V-0 (UL94 Vertical Flame Test)

NEMA ENCLOSURE RATINGS: The Scepter JBox is NEMA Rated 1, 2, 3R, 4, 4X, 6*, 6P*, 12, 13
(*Applies only to sizes 4" to 12" non-hinged covers)

INDUSTRIAL CONTROL PANELS UL 508A: Suitable to be used as an enclosure per section 18 of UL 508A

CONDUCTORS: Suitable for use with 90°C Rated Conductors

NEMA RATING

Type	Description
1	Enclosures for indoor use providing protection from contact with the enclosed equipment and ingress of solid objects (falling dirt).
2	Enclosures for indoor use providing protection from contact with the enclosed equipment, ingress of solid objects (falling dirt) and from harmful effects on equipment due to ingress of water (dripping and light splashing)
3R	Enclosures for indoor or outdoor use providing protection from contact with the enclosed equipment, ingress of solid objects (falling dirt) and from harmful effects on equipment due to ingress of water (rain, sleet, snow) and is undamaged by the external formation of ice.
4	Enclosures for indoor or outdoor use providing protection from contact with the enclosed equipment, ingress of solid objects (falling dirt and windblown dust) and from harmful effects on equipment due to ingress of water (rain, sleet, snow, splashing water and hose directed water) and is undamaged by the external formation of ice.
4X	Enclosures for indoor or outdoor use providing protection from contact with the enclosed equipment, ingress of solid objects (windblown dust) and from harmful effects on equipment due to ingress of water (rain, sleet, snow, splashing water and hose directed water), protection against corrosion and is undamaged by the external formation of ice.
6	Enclosures for indoor or outdoor use providing protection from contact with the enclosed equipment, ingress of solid objects (falling dirt) and from harmful effects on equipment due to ingress of water (hose directed water and entry of water on occasional temporary submersion at a limited depth) and is undamaged by the external formation of ice.
6P	Enclosures for indoor or outdoor use providing protection from contact with the enclosed equipment, ingress of solid objects (falling dirt) and from harmful effects on equipment due to ingress of water (hose directed water and entry of water during prolonged submersion at a limited depth) and is undamaged by the external formation of ice.
12	Enclosures for indoor use providing protection from contact with the enclosed equipment, ingress of solid objects (falling dirt circulating dust, lint, fibers and flyings) and from harmful effects on equipment due to ingress of water (dripping and light splashing).
13	Enclosures for indoor use providing protection from contact with the enclosed equipment, ingress of solid objects (falling dirt circulating dust, lint, fibers and flyings) and from harmful effects on equipment due to ingress of water (dripping and light splashing) and against the spraying, splashing and seepage of oil and non-corrosive coolants.

SCEPTER JBOX PRODUCTS

PRODUCT DIMENSIONS (INCHES)

Size inches	Part Number	Product Code	L1	W1	L2	W2	H1	H2	M1	M2	G1	G2	J1	J2	D	K	Vol.
4x4x2	JBX442	277000	4.97	3.93	3.48	3.48	2.90	2.52	4.48	3.44	2.41	1.09	1.72	1.09	0.51	0.24	25.55
4x4x4	JBX444	277001	4.90	3.86	3.48	3.48	4.89	4.52	4.41	3.37	2.22	2.97	1.59	2.97	0.59	0.24	50.11
5x5x2	JBX552	277002	5.97	4.93	4.93	4.55	2.90	2.52	5.48	4.44	3.41	1.09	2.69	1.09	0.51	0.24	41.89
6x3x4	JBX634	277003	3.90	5.86	5.86	5.48	4.89	4.52	3.41	5.37	1.22	2.72	3.42	2.72	0.59	0.28	56.03
6x6x4	JBX664	277004	7.58	7.58	7.58	7.20	4.90	4.52	6.90	6.90	4.47	2.47	4.47	2.47	0.59	0.28	172.05
6x6x6	JBX666	277005	7.51	7.51	7.51	7.13	6.90	6.52	6.83	6.83	4.22	4.47	4.22	4.47	0.72	0.28	255.00

NEMA Rated for JBox with Standard Cover 4" - 6"
1,2,3R,4,4X,6,6P,12,13

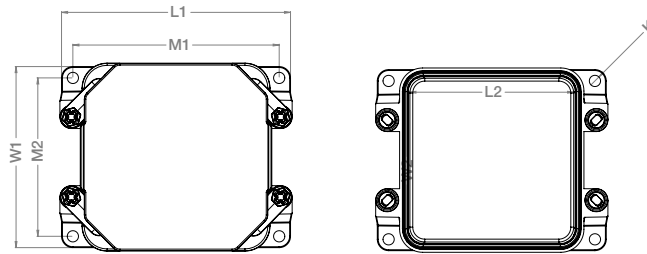

JBX442 - JBX666

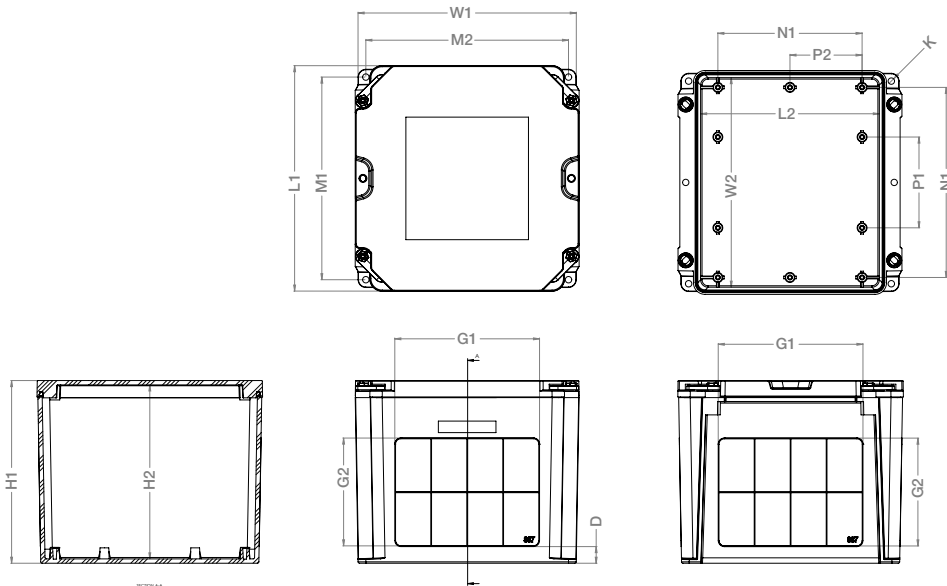

JBX884 - JBX887

Size inches	Part Number	Product Code	L1	W1	L2	W2	H1	H2	M1	M2	G1	G2	N1	N2	P1	P2	D	K	Vol.
8x8x4	JBX884	277006	9.58	9.58	7.86	9.20	4.90	4.52	8.90	8.90	6.47	1.97	8.25	6.26	3.94	3.13	0.59	0.28	293.19
8x8x7	JBX887	277007	9.47	9.47	7.76	9.10	7.90	7.52	8.90	8.90	6.22	4.65	8.25	6.26	3.94	3.13	0.75	0.28	506.97
12x12x4	JBX12124	277008	13.58	12.24	11.74	11.74	4.90	4.46	12.90	11.56	9.28	2.03	10.26	10.25	3.94	3.13	0.56	0.28	548.26
12x12x6	JBX12126	277009	13.58	12.24	11.74	11.74	6.90	6.46	12.90	11.56	9.03	3.78	10.26	10.25	3.94	3.13	0.67	0.28	822.21
12x12x8	JBX12128	277010	13.58	12.24	11.74	11.74	8.90	8.46	12.90	11.56	8.81	5.64	10.26	10.25	3.94	3.13	0.76	0.28	1092.90
14x14x8	JBX14148	277011	15.72	14.39	13.80	13.80	9.10	8.61	15.10	13.70	11.05	5.69	12.25	10.26	3.94	3.16	0.83	0.33	1535.00
14x14x10	JBX141410	277012	15.72	14.39	13.80	13.80	11.10	10.52	15.10	13.70	11.05	7.55	12.25	10.26	3.94	3.16	0.83	0.33	1916.00
16x16x10	JBX161610	277013	17.64	16.30	15.71	15.71	11.10	10.52	17.00	15.60	12.55	7.55	14.25	12.26	4.71	4.09	0.83	0.33	2520.00

NEMA Rated for JBox with Standard Cover 8" - 12"
1,2,3R,4,4X,6,6P,12,13

NEMA Rated for JBox with Standard Cover 14" & 16"
1,2,3R,4,4X,12,13

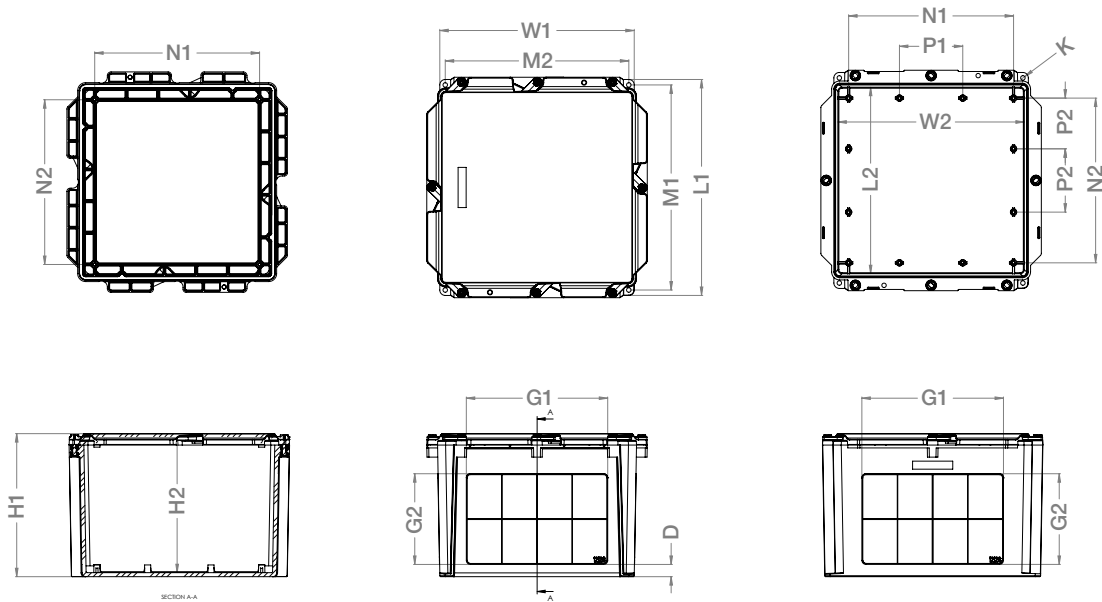

JBX12124 - JBX12128

Size inches	Part Number	Product Code	W	H	A	B	C
Back Panels							
6x6	BP66CSW	077864	4.88	6.75	4.26	6.25	0.25
8x8	BP88CSW	077861	6.88	8.75	6.26	8.25	0.25
12x10	BP1210CSW	077862	8.88	10.75	8.26	10.25	0.25
12x12	BP1212CSW	077865	10.88	10.75	10.26	10.25	0.25
14x14	BP1414CSW	077867	10.88	12.75	10.26	12.25	0.25
16x16	BP1616CSW	077868	12.88	14.75	12.26	14.25	0.25

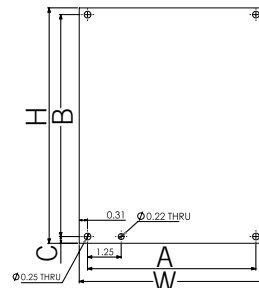

SCEPTER JBOX HINGED COVER

Tested to perform in industrial environments, the Scepter JBox Hinged Cover junction box has added features to make this the easiest box to use – no matter the situation.

The Hinged Cover opens more than 200° for complete and easy access to control devices and instruments and is designed to work with your existing PVC conduit runs. The Scepter JBox Hinged Cover is NEMA 3R and 4X rated, ideally suited for indoor and outdoor use and in wash-down environments. It is 100% non-metallic and includes all the features that users have come to appreciate in the Scepter JBox.



PRODUCT DIMENSIONS (INCHES)

Size inches	Part Number	Product Code	L1	W1	L2	W2	H1	H2	M1	M2	G1	G2	N1	N2	P1	P2	D	K	Vol.
8x8x4	JBXH884	277100	9.58	9.58	7.86	9.20	4.90	4.52	8.90	8.90	6.47	1.97	8.25	6.26	3.94	3.13	0.59	0.28	293.19
8x8x7	JBXH887	277101	9.47	9.47	7.86	9.20	7.90	7.52	8.90	8.90	6.22	4.65	8.25	6.26	3.94	3.13	0.75	0.28	506.97
12x10x6	JBXH12106	277102	11.51	12.17	9.67	11.67	6.90	6.46	10.80	10.80	8.03	3.78	10.25	8.26	3.94	2.16	0.67	0.28	682.15
12x12x4	JBXH12124	277103	13.58	12.24	11.74	11.74	4.90	4.46	12.90	12.90	9.28	2.03	10.26	10.25	3.94	3.13	0.56	0.28	548.26
12x12x6	JBXH12126	277104	13.58	12.24	11.74	11.74	6.90	6.46	12.90	12.90	9.03	3.78	10.26	10.25	3.94	3.13	0.67	0.28	822.21
12x12x8	JBXH12128	277105	13.58	12.24	11.74	11.74	8.90	8.46	12.90	12.90	8.81	5.64	10.26	10.25	3.94	3.13	0.76	0.28	1092.9
14x14x8	JBXH14148	277106	15.72	14.39	13.80	13.80	9.10	8.46	15.10	15.10	11.05	5.69	12.25	10.26	3.94	3.16	0.83	0.33	1535.0
14x14x10	JBXH141410	277107	15.72	14.39	13.80	13.80	11.10	10.52	15.10	15.10	11.05	7.55	12.25	10.26	3.94	3.16	0.83	0.33	1916.0
16x16x10	JBXH161610	277108	17.64	16.3	15.71	15.71	11.1	10.52	17	17	12.55	7.55	14.25	12.26	4.71	4.09	0.83	0.33	2520.0

NEMA Rated for JBox with Hinged Cover
1,2,3R,4,4X,12,13

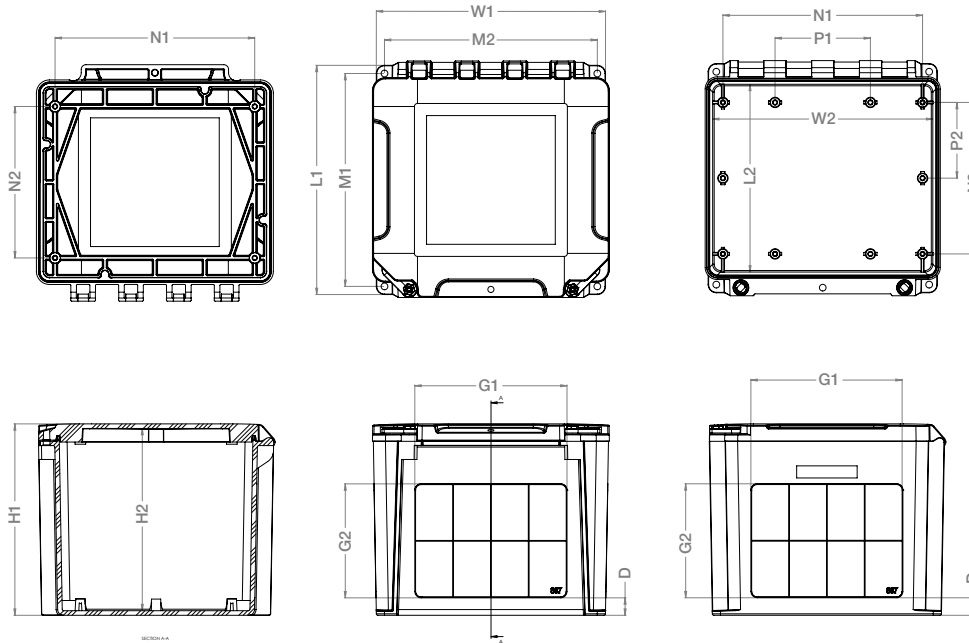

JBXH884 - JBXH887

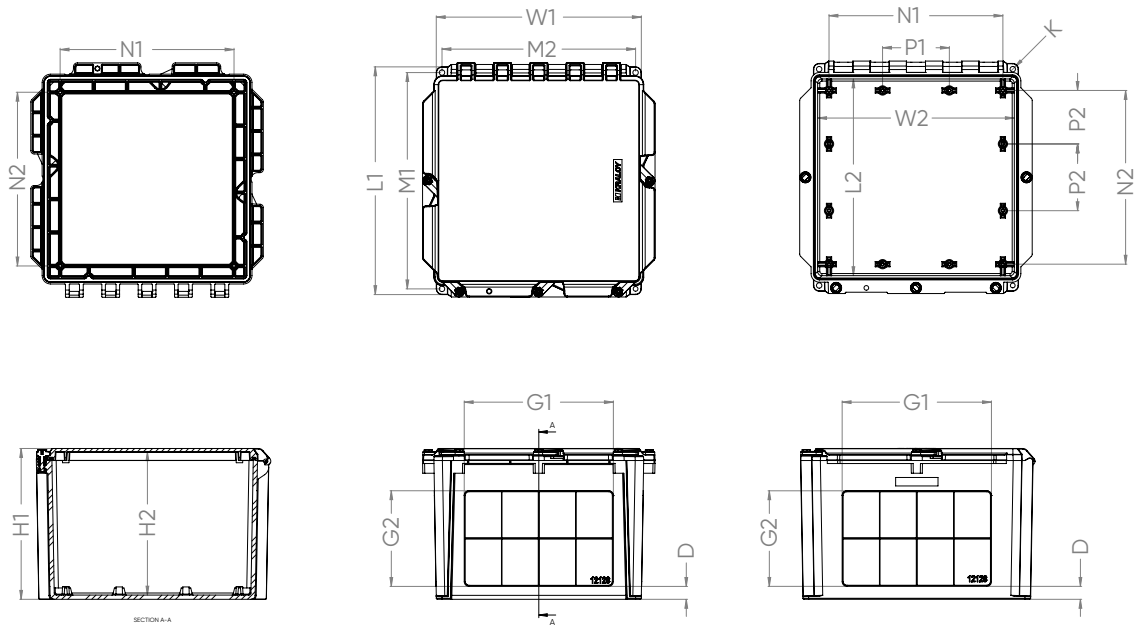

JBXH12106 - JBXh12128

EPR KITS FOR CONDUIT REPAIR

REPAIRS CONDUIT as easy as 1-2-3

These clever and innovative conduit repair kits from IPEX are the first total repair systems for broken and damaged PVC conduit. They offer fast and easy repairs for damaged conduit caused by actions such as earth excavation, horizontal and core drilling.

EPR Kits are manufactured of high-impact and non-conductive PVC, ensuring a life long quality repair for your system. All sizes are 24 inches in length.

With unique interlocking joints, the EPR Kits' two half shell bell by bell pieces simply close around the installed wire and cable. Using standard PVC solvent cement, EPR Kits are quickly and easily assembled and connected, restoring the conduit to its original form. And, unlike other conduit repair systems, EPR Kits are capable of repairing various lengths and types of pipe quickly and accurately, saving you time and money.

STEPS 1-2-3

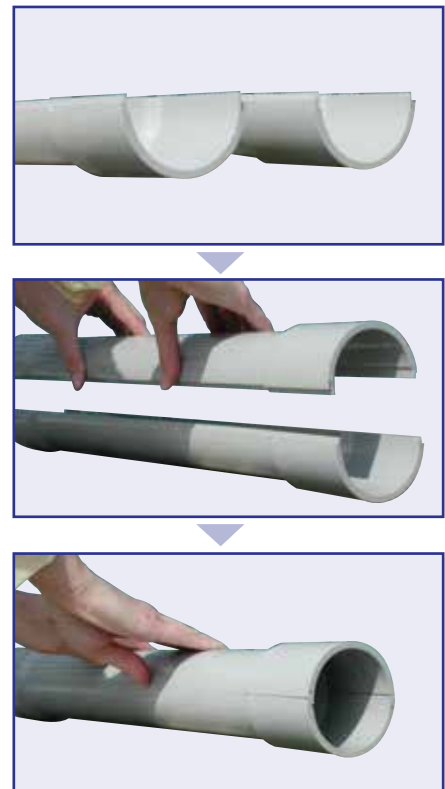

ADVANTAGES

RESTORES structural integrity of conduit system

COST SAVINGS with fast and easy installation

COMPATIBILITY – inside diameter of bell equals outside diameter of pipe to create a bell and spigot connection

SPECIAL INTERLOCKING JOINTS provide water-tight seal

PACKAGING includes easy to follow instruction sheet

IDEAL FOR THE REPAIR OF SCHEDULE 40 AND 80 RIGID PVC CONDUIT in electrical, telecommunication, utility and CATV applications

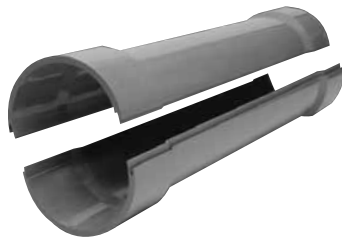

EPR KITS FOR CONDUIT REPAIR

Size (in)	Part Number	Product Code	Length (in)
1-1/4	EPR25	077982	24
1-1/2	EPR30	077981	24
2	EPR35	077980	24
2-1/2	EPR40	077960	24
3	EPR45	077958	24
4	EPR55	077957	24
5	EPR60	077956	24
6	EPR65	077955	24

SALES AND CUSTOMER SERVICE

Customers call IPEX USA LLC.

Toll free: (800) 463-9572

www.ipexna.com

About IPEX by Aliaxis

As leading suppliers of thermoplastic piping systems, IPEX by Aliaxis provides our customers with some of the world's largest and most comprehensive product lines. All IPEX by Aliaxis products are backed by more than 50 years of experience. With state-of-the-art manufacturing facilities and distribution centers across North America, we have earned a reputation for product innovation, quality, end-user focus and performance.

Markets served by IPEX by Aliaxis products are:

- Electrical systems
- Telecommunications and utility piping systems
- PVC, CPVC, PP, PVDF, PE, ABS, and PEX pipe and fittings
- Industrial process piping systems
- Municipal pressure and gravity piping systems
- Plumbing and mechanical piping systems
- Electrofusion systems for gas and water
- Industrial, plumbing and electrical cements
- Irrigation systems

Product is manufactured by IPEX Electrical Inc. and distributed in the United States by IPEX USA LLC.

JBox™ is a trademark of IPEX Branding Inc.

This literature is published in good faith and is believed to be reliable. However it does not represent and/or warrant in any manner the information and suggestions contained in this brochure. Data presented is the result of laboratory tests and field experience.

A policy of ongoing product improvement is maintained. This may result in modifications of features and/or specifications without notice.



IPEX
by **alixis**

BRELSIP230801U
© 2023 IPEX EL0021



DISTRIBUTED BY